

Solid State

Course Outline

The course illustrates the

- Different types of defects in crystals,
- Structure of various inorganic solids
- Diffusion mechanisms in solids
- Solid state reactions
- Synthesis of solids
- Phase transition in solids
- Crystal growth
- Solid electrolytes

IMPERFECTIONS IN SOLIDS

- Any deviation from completely ordered arrangement of constituent particles in a crystal is called disorder or a defect.

Types of Imperfections

- Vacancy atoms
- Interstitial atoms
- Substitutional atoms

Point defects

- Dislocations

Line defects

- Grain Boundaries

Area defects



CRYSTAL DEFECTS AND IMPERFECTIONS

Crystal imperfections can be classified on the basis of their geometry as,

- ❑ Point Imperfections,
- ❑ Line imperfections
- ❑ Surface (or) plane imperfections and
- ❑ Volume imperfections

TYPES OF DEFECTS

- (1) **Point defects** :- The defects which arise due to the irregularity or deviations from ideal arrangement of atoms around a point or point or an atom in a crystalline substance are called point defects or atomic imperfections.
- (2) **line defects** :- The defects which arise due to irregularities or deviations from ideal arrangement in entire row of of lattice point are called line defects.

- These irregularities are called crystal defects or crystal imperfections.

POINT DEFECTS IN SOLIDS

- (1) Vacancy defect.
- (2) interstitial defect.
 - (a) Defects in stoichiometric crystals.
 - (b) Defects in non stoichiometric crystals.
 - (c) Impurity defects.



POINT IMPERFECTIONS

- ❖ They are imperfect point- like regions, one or two atomic diameters in size and hence referred to as ‘zero dimensional imperfections’.
- ❖ There are different kinds of point imperfections.
VACANCIES
- ❖ If an atom is missing from its normal site in the matrix, the defect is called a *vacancy defect*.
- ❖ It may be a single vacancy, divacancy or a trivacancy.



POINT DEFECT-VACANCY





POINT IMPERFECTIONS

- ❑ In metals vacancies are created by thermal excitation.
- ❑ When the temperature is sufficiently high, as the atoms vibrate around their regular positions, some acquire enough energy to leave the site completely.
- ❑ When the regular atom leaves, a vacancy is created.
- ❑ A pair of one cation and one anion can be missed from an ionic crystal. Such a pair of vacant ion sites is called *Schottky imperfection*.
- ❑ This type of defect is dominant in alkali halides.



SCHOTTKY IMPERFECTIONS

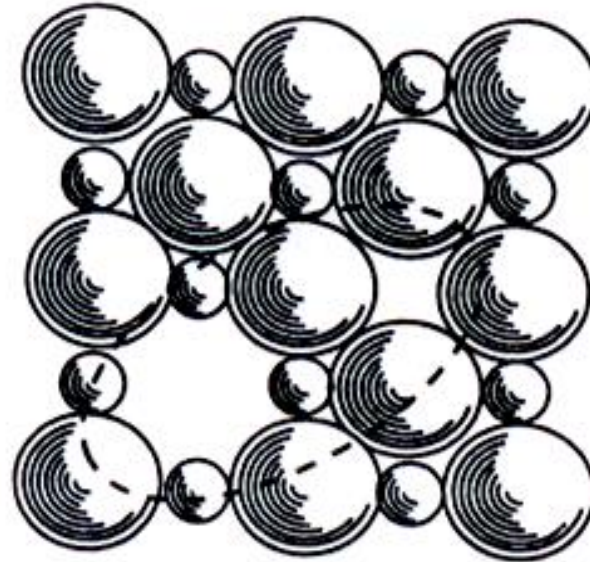



SUBSTITUTIONAL IMPURITY

- + It refers to a foreign atom that substitutes for or replaces a parent atom in the crystal.
- + Pentavalent or trivalent impurity atoms doped in Silicon or Germanium are also substitutional impurities in the crystal.



SUBSTITUTIONAL IMPURITY





INTERSTITIAL IMPURITY

- ✚ An interstitial defect arises when an atom occupies a definite position in the lattice that is not normally occupied in the perfect crystal.
- ✚ In crystals, packing density is always **less than 1**.
- ✚ If a small sized atom occupies the void space in the parent crystal without disturbing the parent atoms from their regular sites, then it is called as '*interstitial impurity*'.



INTERSTITIAL IMPURITY





INTERSTITIAL IMPURITY

- ✚ In ionic crystals, an ion displaced from a regular site to an interstitial site is called '*Frenkel imperfection*'.
- ✚ As cations are generally the smaller ones, it is possible for them to get displaced into the void space.
- ✚ Anions do not get displaced as the void space is too small compared to the size of the anions.
- ✚ A Frenkel imperfection does not change the overall electrical neutrality of the crystal. This type of defect occurs in silver halides and CaF_2 .



DIAGRAM SHOWING THE IMPERFECTIONS

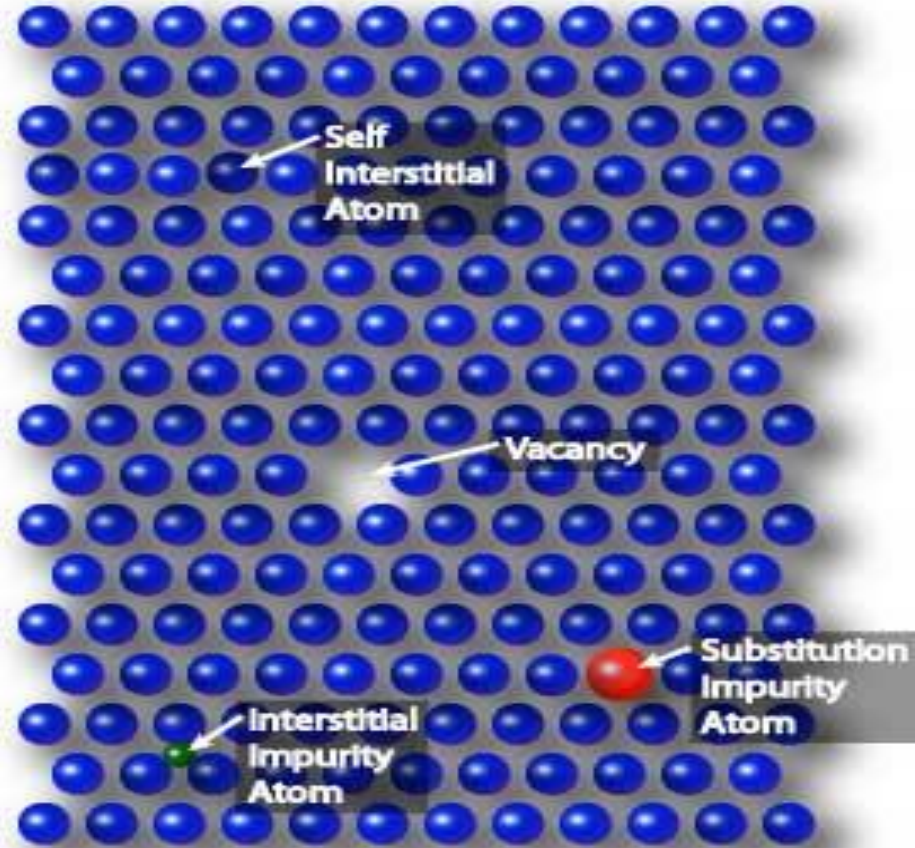



ELECTRONIC DEFECTS

- ✚ Errors in charge distribution in solids are called '*electronic defects*'.
- ✚ These defects are produced when the composition of an ionic crystal does not correspond to the exact stoichiometric formula.
- ✚ These defects are free to move in the crystal under the influence of an electric field.



EFFECT OF POINT IMPERFECTIONS

- ✚ The presence of a point imperfection introduces distortions in the crystal.
- ✚ In the case of impurity atom, because of its difference in size, elastic strains are created in the regions surrounding the impurity atom.
- ✚ All these factors tend to increase the potential energy of the crystal called '*enthalpy*'.
- ✚ The work done for the creation of such a point defect is called the '*enthalpy of formation*' of the point imperfection.



LINE IMPERFECTIONS

- ✚ The defects, which take place due to dislocation or distortion of atoms along a line, in some direction are called as '*line defects*'.
- ✚ Line defects are also called dislocations. In the geometric sense, they may be called as 'one dimensional defects'.
- ✚ A dislocation may be defined as a disturbed region between two substantially perfect parts of a crystal.
- ✚ It is responsible for the phenomenon of slip by which most metals deform plastically.



LINE IMPERFECTIONS

The two types of dislocations are,

✚ Edge dislocation

✚ Screw dislocation



EDGE DISLOCATION

- ✚ In perfect crystal, atoms are arranged in both vertical and horizontal planes parallel to the side faces.
- ✚ If one of these vertical planes does not extend to the full length, but ends in between within the crystal it is called '*edge dislocation*'.
- ✚ In the perfect crystal, just above the edge of the incomplete plane the atoms are squeezed and are in a state of compression.
- ✚ Just below the edge of the incomplete plane, the atoms are pulled apart and are in a state of tension.



EDGE DISLOCATION

- ✚ The distorted configuration extends all along the edge into the crystal.
- ✚ Thus as the region of maximum distortion is centered around the edge of the incomplete plane, this distortion represents a line imperfection and is called an edge dislocation.
- ✚ Edge dislocations are represented by ' \perp ' or 'T' depending on whether the incomplete plane starts from the top or from the bottom of the crystal.
- ✚ These two configurations are referred to as positive and negative edge dislocations respectively.



EDGE DISLOCATION

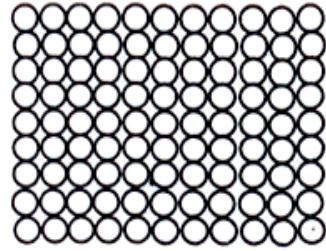
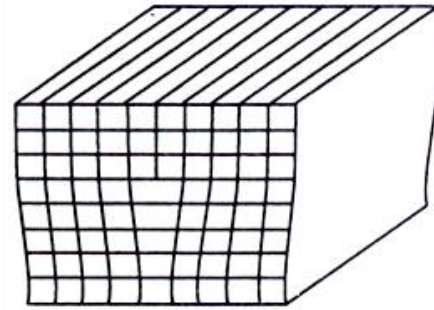
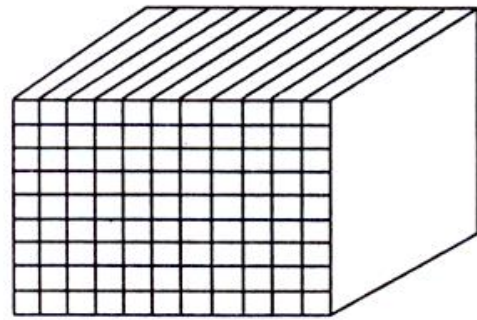

(a)

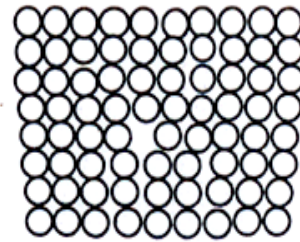

(b)



BURGERS VECTOR

- ✚ The magnitude and the direction of the displacement are defined by a vector, called the *Burgers Vector*.
- ✚ In figure (a), starting from the point P, we go up by 6 steps, then move towards right by 5 steps, move down by 6 steps and finally move towards left by 5 steps to reach the starting point P. Now the Burgers circuit gets closed.
- ✚ When the same operation is performed on the defect crystal (figure (b)) we end up at Q instead of the starting point.



BURGERS VECTOR

- ✚ So, we have to move an extra step to return to P, in order to close the Burgers circuit.
- ✚ The magnitude and the direction of the step defines the Burgers Vector (BV).
- ✚ $BV = \overrightarrow{QP} = b$
- ✚ The Burgers Vector is perpendicular to the edge dislocation line.



BURGERS VECTOR

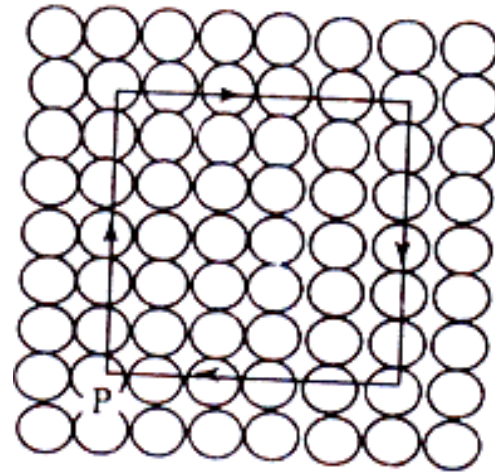

(a)

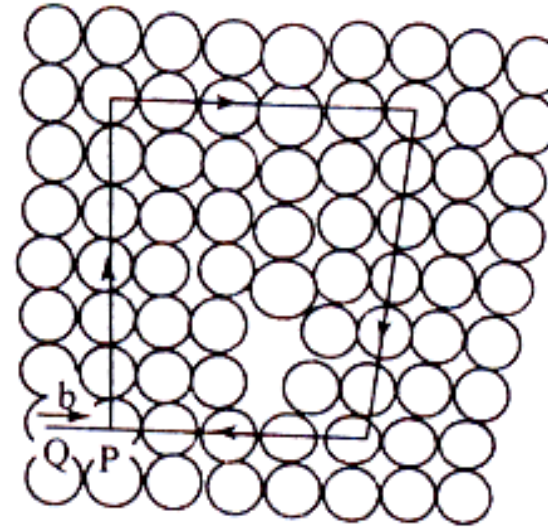

(b)



SCREW DISLOCATION

- ✚ In this dislocation, the atoms are displaced in two separate planes perpendicular to each other.
- ✚ It forms a spiral ramp around the dislocation.
- ✚ The Burgers Vector is parallel to the screw dislocation line.
- ✚ Speed of movement of a screw dislocation is lesser compared to edge dislocation. Normally, the real dislocations in the crystals are the mixtures of edge and screw dislocation.

VACANCY DEFECTS

When some of the lattice sites are vacant, the crystal is said to have vacancy defect.

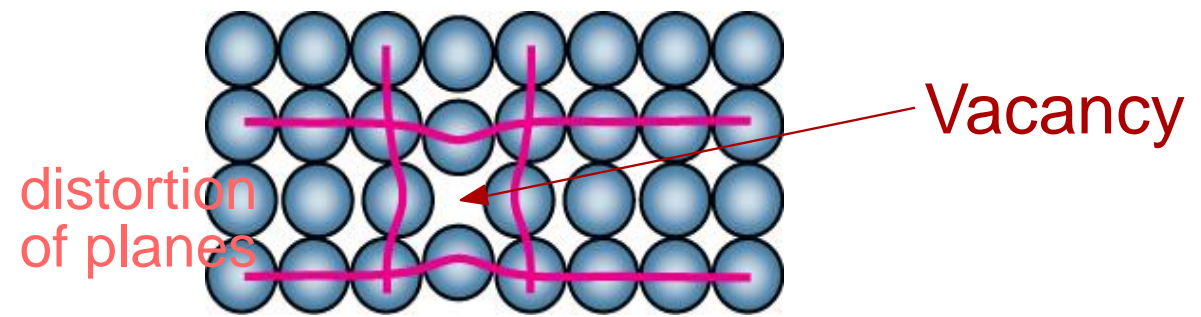
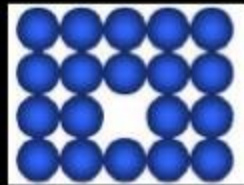

INTERSTITIAL DEFECTS

When some constituent particles (atoms or molecules) occupy vacant interstitial positions, the crystal is said to have interstitial defects.

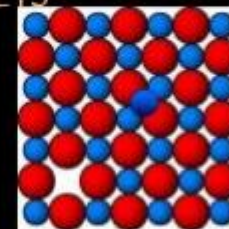

B. POINT DEFECTS IN NON-STOICHIOMETRIC CRYSTALS

- The compound in which the ratio of positive and negative ions present in the compound differs from that required by ideal chemical formula of the compound are called non-stoichiometric defects.
- These are of two types :-
- (A.) metal excess defects
- (B.) metal deficient defects

SCHOTTKY DEFECT

It arises if some of the atoms or ions are missing from their normal lattice sites.

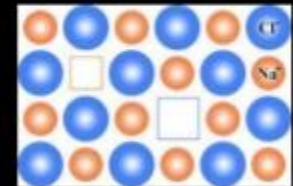

Conditions causing Schottky defects :-

1. High co-ordination number
2. Ions of almost similar size.

FRENKEL DEFECT

It arises when an ion is missing from its normal position and occupies an interstitial site between the lattice points.

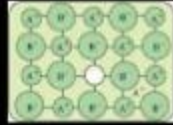

Condition causing Frenkel defects

1. co-ordination number is low
2. Anions are much larger in size than the cations.

B. POINT DEFECTS IN NON-STOICHIOMETRIC CRYSTALS

- The compound in which the ratio of positive and negative ions present in the compound differs from that required by ideal chemical formula of the compound are called non-stoichiometric defects.
- These are of two types :-
 - (A.1) metal excess defects
 - (B.1) metal deficient defects

(A.1) METAL EXCESS DEFECTS

- In these defects the positive ions are in excess. These may arise due to the following two ways :-
- 1. anionic vacancies
- 2. presence of extra cations in interstitial sites.

ANION VACANCIES

In this case,
negative ions may
be missing from
their lattice
electrical neutrality.

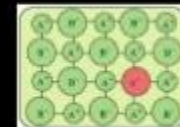

EXCESS CATIONS OCCUPYING INTERSTITIAL SITES

In this case, there are extra positive ions occupying interstitial sites and the electrons in another interstitial sites to maintain electrical neutrality.

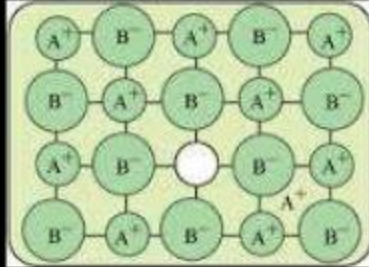

(B.1) METAL DEFICIENT DEFECTS

- These contains less number of positive ions than negative ions. These arise due to two ways :-
- 1. Cation vacancies
- 2. Extra anions occupying interstitial sites.

CATION VACANCIES

In some cases, the positive ions may be missing from their lattice sites.



EXTRA ANIONS OCCUPYING INTERSTITIAL SITES

In this case, the extra anions may be occupying interstitial sites position .

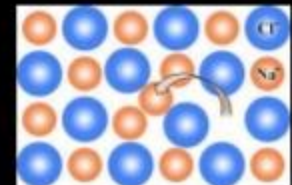

(C) IMPURITY DEFECTS



These defects in ionic crystals arise due the presence of some impurity ions at the lattice sites or at the vacant interstitial sites.

- Structure of Compounds of AX (Zinc Blende, Wurtizite)
- Structure of Compounds of AX₂ (Fluorite, Antifluorite)
- Structure of Compounds of ABX₃ (Perosvskite, Illmenite)
- Spinel and Inverse Spinel Lectures

Diamond Structure

- The *Diamond Lattice* consists of **2 interpenetrating FCC Lattices**.
- It is not a Bravais Lattice. There are **8 atoms in the unit cell**. Each atom **bonds covalently to 4 others equally spaced about a given atom**.

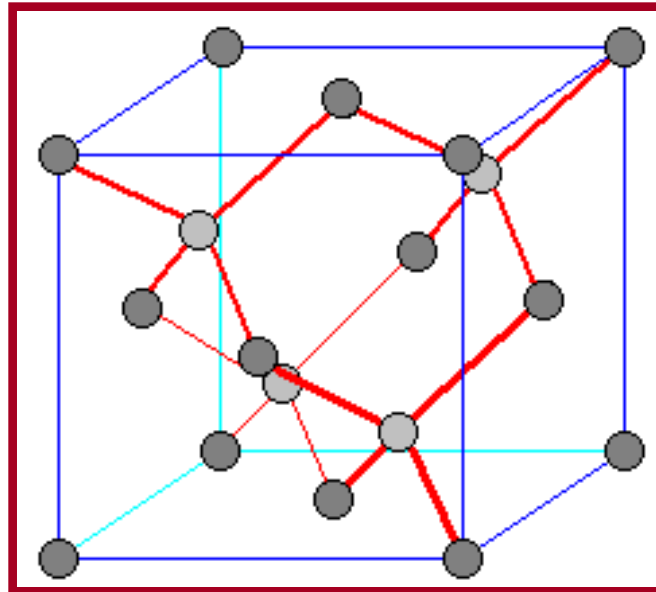

- The *Diamond Lattice* consists of **2 interpenetrating FCC Lattices**.
- The **Coordination Number = 4**.
- The diamond lattice is not a Bravais lattice.

C, Si, Ge & Sn crystallize in the Diamond structure.

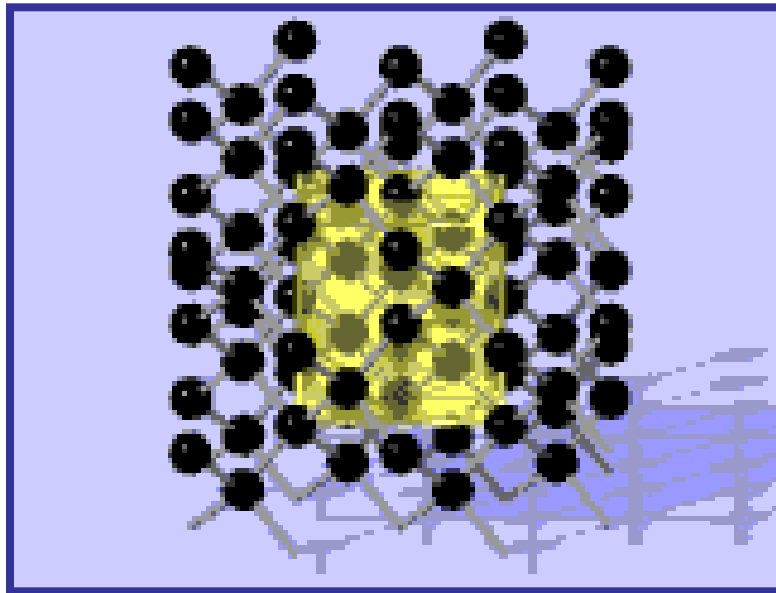

Diamond Lattice

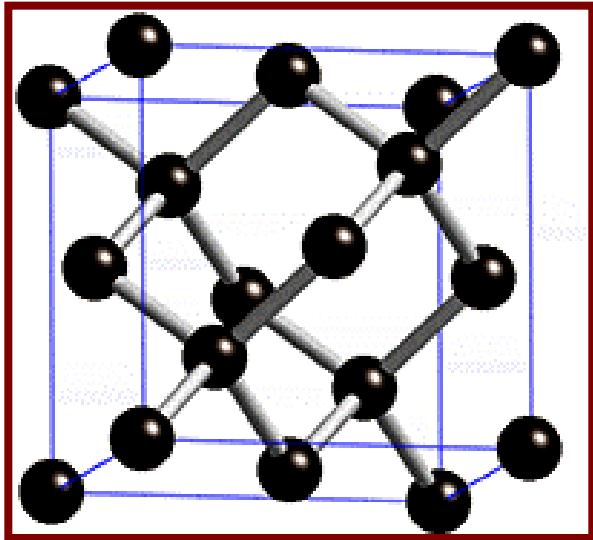
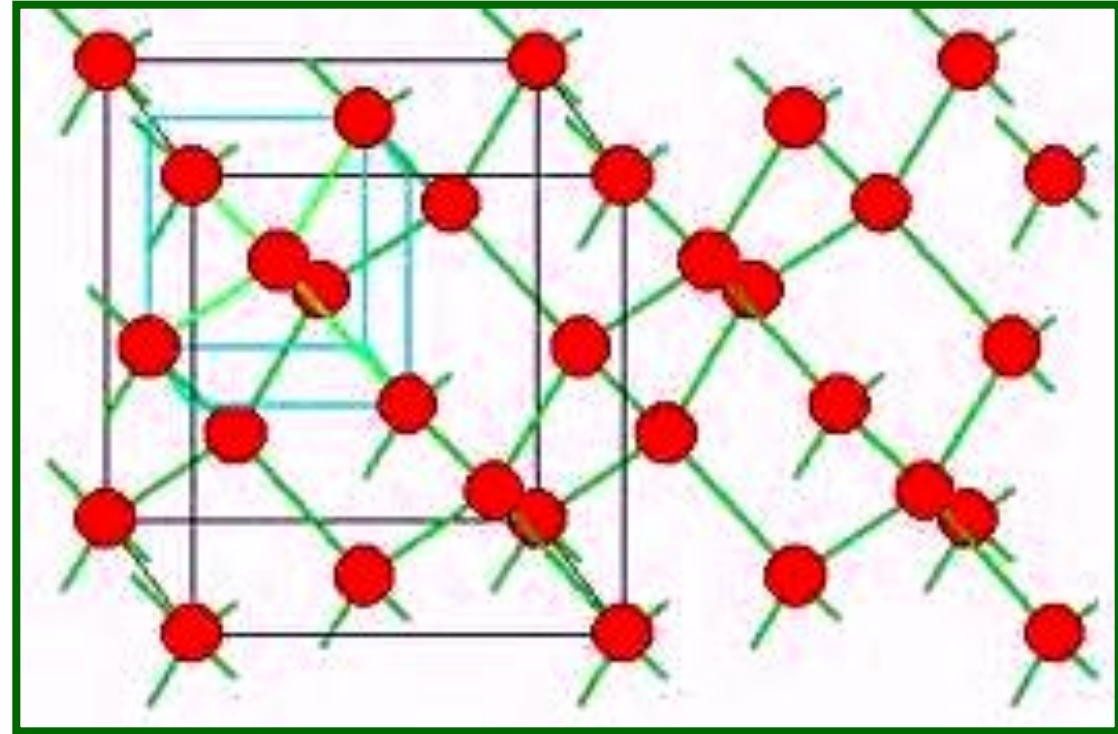
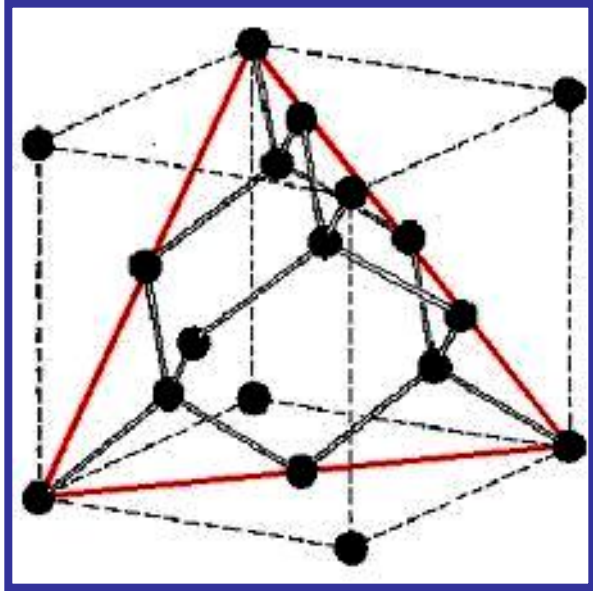

Diamond Lattice
The Cubic Unit Cell

Zinc Blende or ZnS Structure

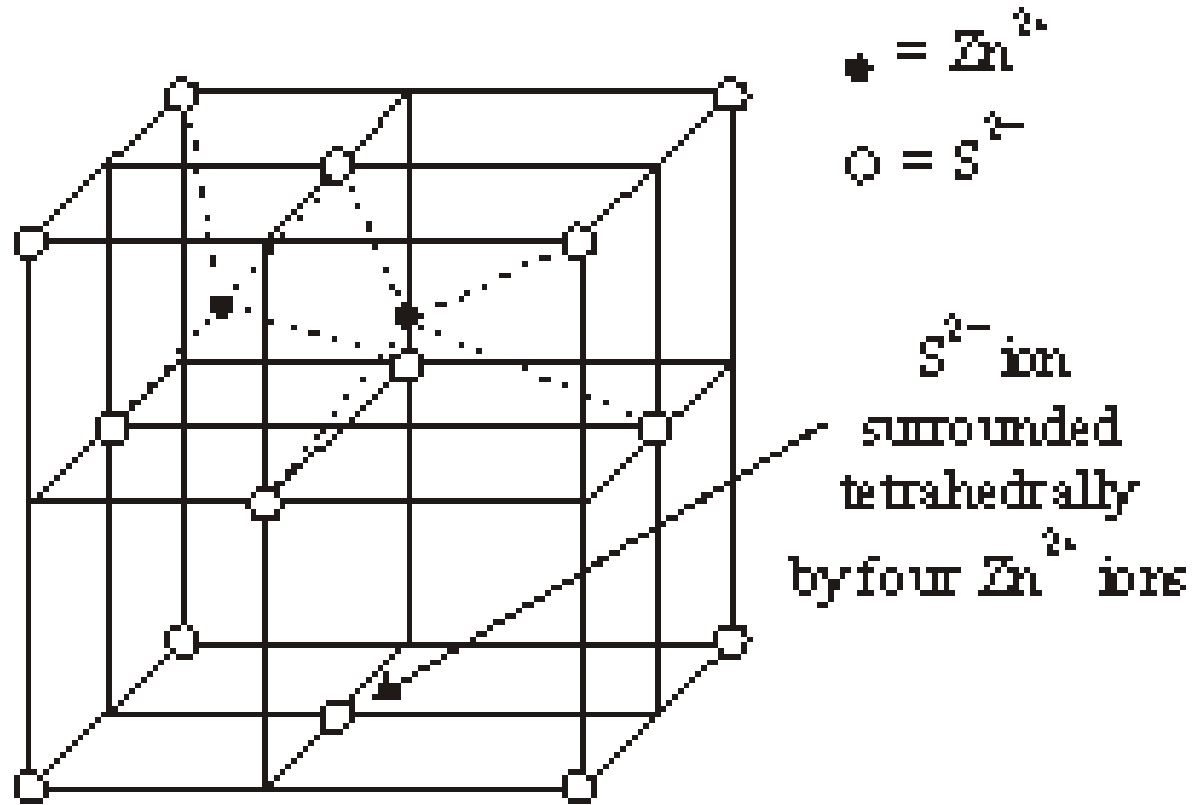

Zinc Blende or ZnS Structure

- Sulphide ions are arranged in ccp arrangement, ie corners of the cube and at the centre of each face
- Zinc ions occupy half of the tetrahedral sites
- There are two tetrahedral sites per atom in a close packed lattice
- There are two tetrahedral sites per sulphide ion
- Only half of the tetrahedral sites are occupied by Zn^{2+} ion
- Stoichiometry of the compound is 1 : 1
- Each Zinc ion is surrounded by four sulphide ions and vice versa
- Coordination number is 4
- Radius ratio is 0.4

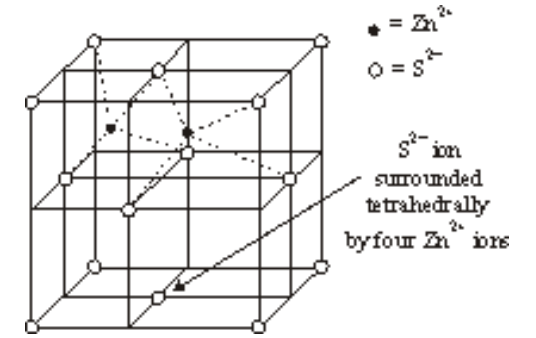

Zinc Blende or ZnS Structure

- The Zincblende Structure has equal numbers of zinc and sulfur ions distributed on a diamond lattice, so that

Each has 4 of the opposite kind as nearest-neighbors.

- This structure is an example of a lattice with a basis, both because of the geometrical position of the atoms & because two types of atoms occur.

Zinc Blende or ZnS Structure

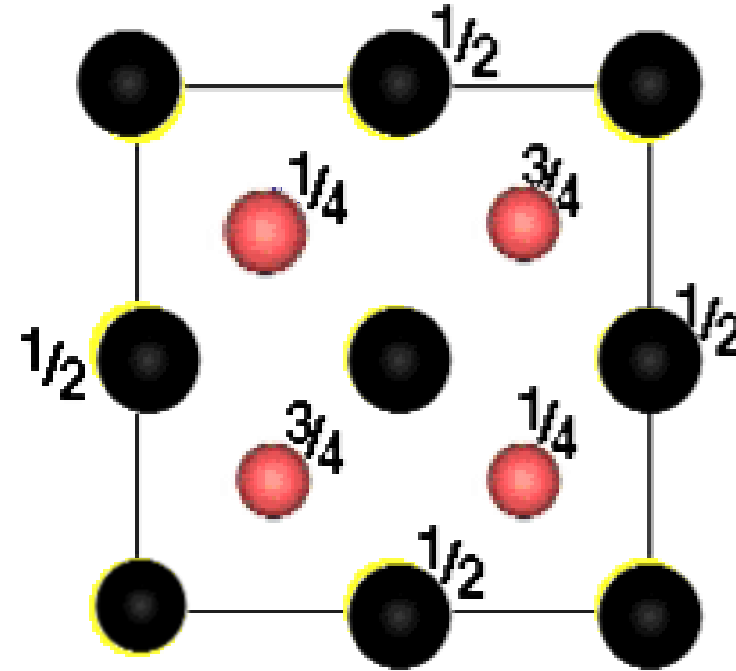
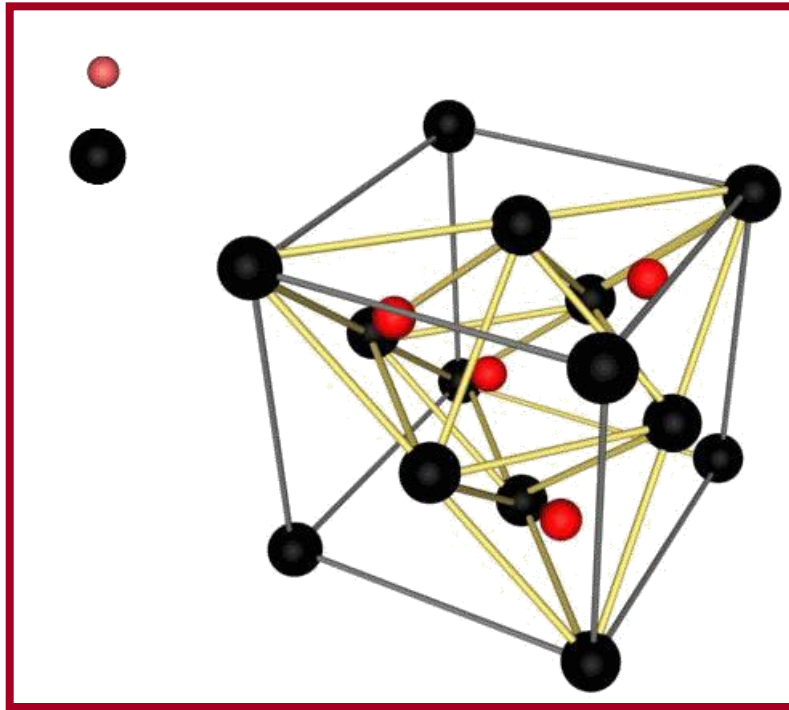

- Some compounds with this structure are:

AgI, GaAs, GaSb, InAs,

Zincblende (ZnS) Lattice

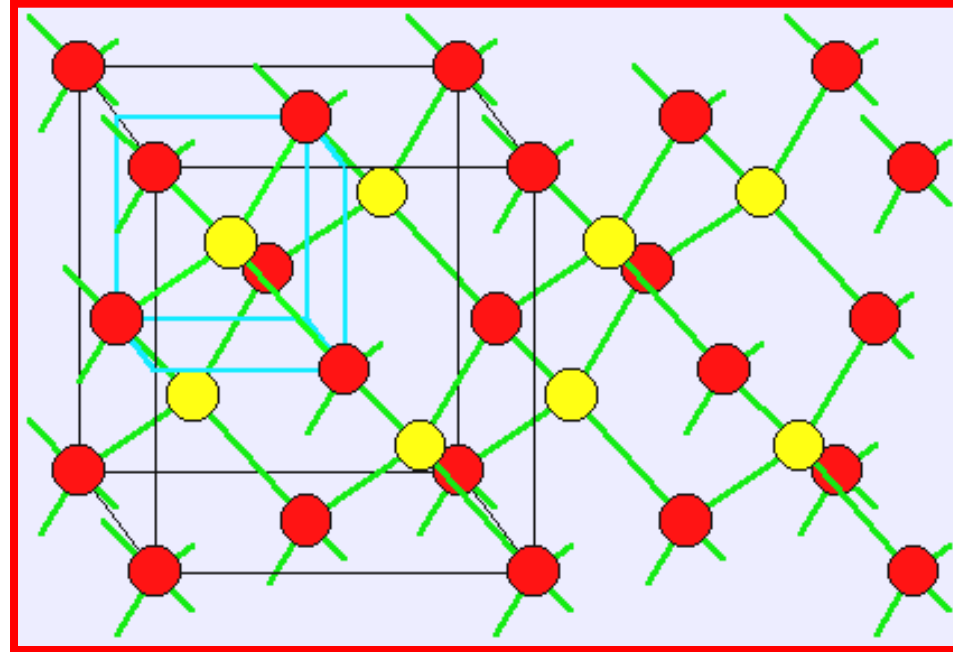
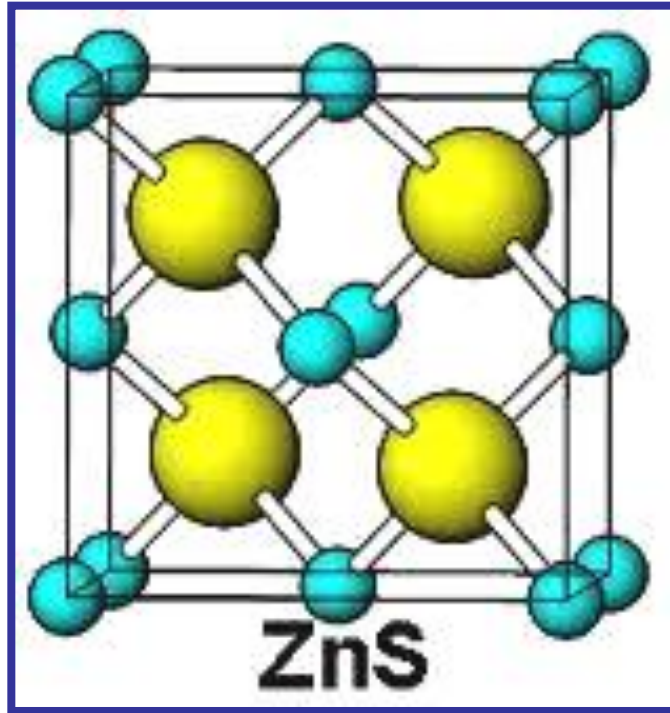

Zincblende Lattice
The Cubic Unit Cell

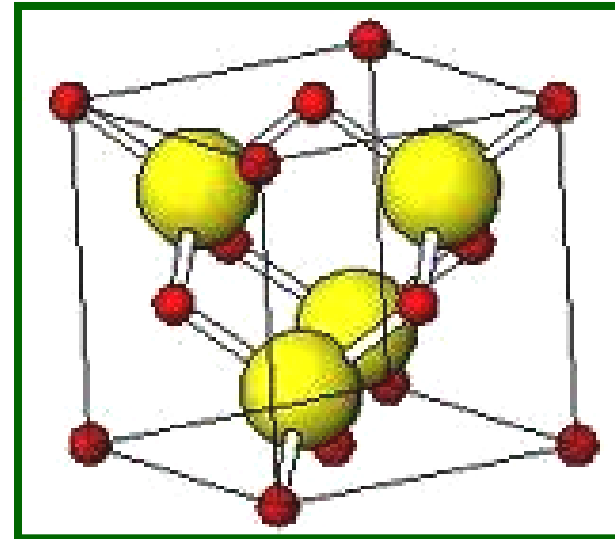

Diamond & Zincblende Structures

A brief discussion of both of these structures & a comparison.

- These two are technologically important structures because many common semiconductors have
Diamond or Zincblende Crystal Structures
- They obviously share the same geometry.
- In both structures, the atoms are all tetrahedrally coordinated. That is, atom has 4 nearest-neighbors.
- In both structures, the basis set consists of **2 atoms**.
In both structures, the primitive lattice
≡ Face Centered Cubic (FCC).
- In both the Diamond & the Zincblende lattice there are 2 atoms per fcc lattice point.
In Diamond: The 2 atoms are the same.
In Zincblende: The 2 atoms are different.

Diamond & Zincblende Lattices

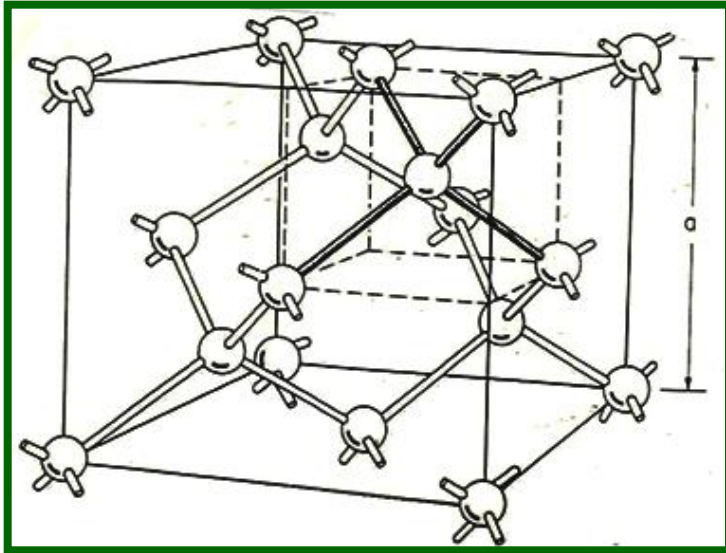

Diamond Lattice
The Cubic Unit Cell

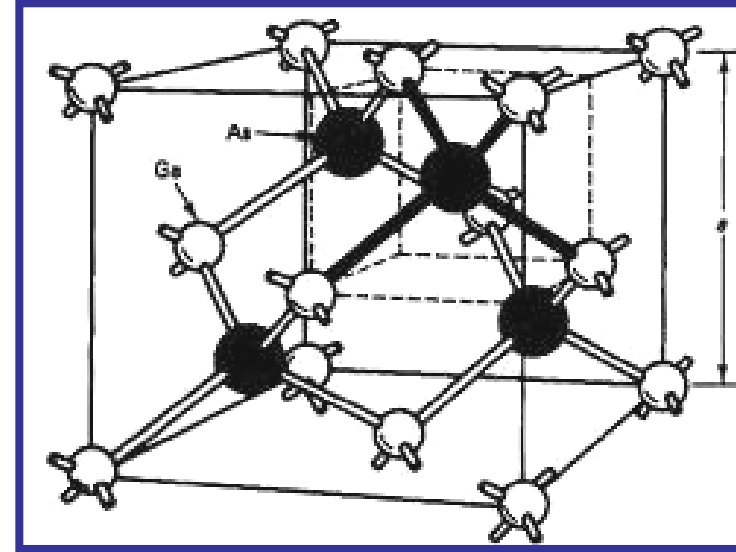

Zincblende Lattice
The Cubic Unit Cell

Other views of
the cubic unit cell

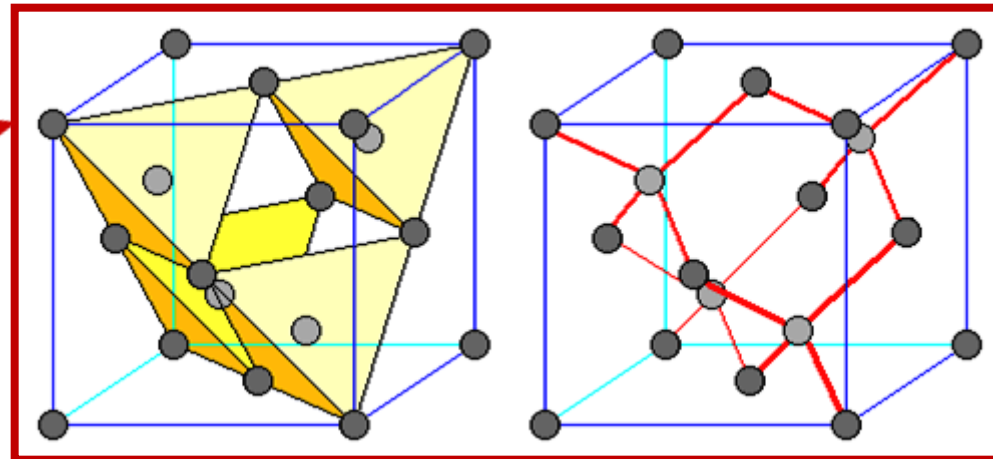

A view of the tetrahedral coordination
& the 2 atom basis

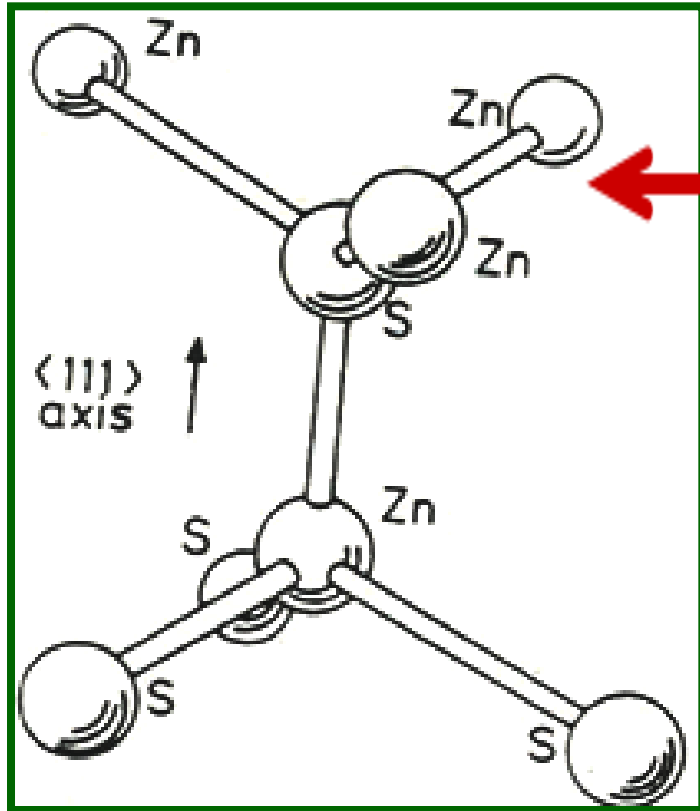

**Zincblende &
Diamond Lattices \equiv
Face Centered Cubic
(**FCC**) lattices with a
2 atom basis**

- The alignment of the layers of ions is the main difference between wurtzite and zinc blende (sphalerite).
- Wurtzite has a hexagonal prism structure whereas zinc blende has a cubic structure.
- So wurtzite has a hcp(hexagonal closely packed) structure whereas zinc blende has a ccp(cubic closely packed) structure

Zincblende vs. wurtzite

Zincblende and wurtzite are examples of **polymorphs**

(Diamond and graphite are **allotropes**, which are elemental polymorphs)

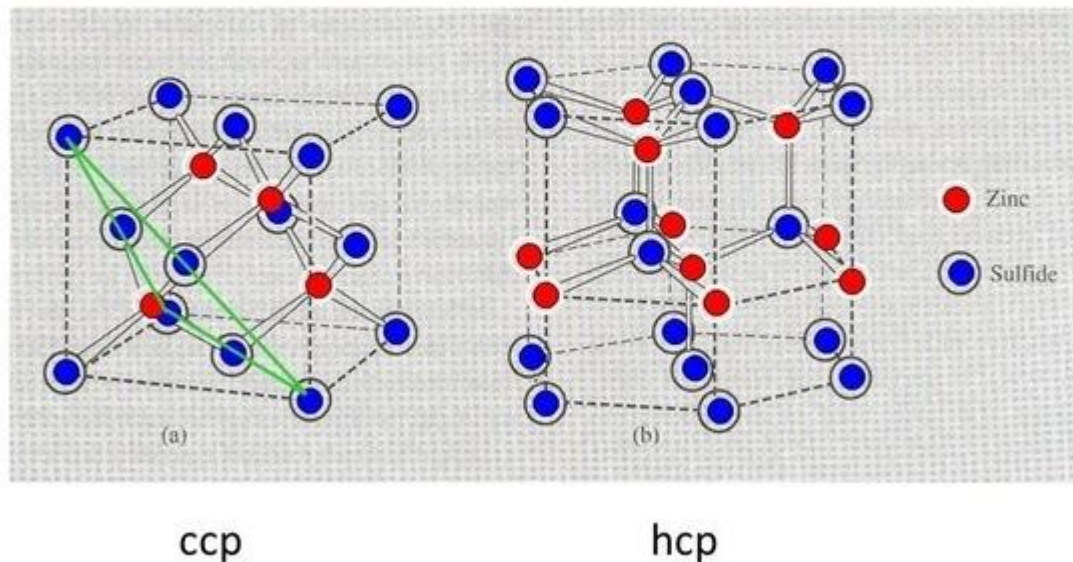

The Wurtzite Structure

- Sulphide ions are arranged in hcp arrangement,
- Zinc ions occupy half of the tetrahedral sites
- There are two tetrahedral sites per atom in a close packed lattice
- There are two tetrahedral sites per sulphide ion
- Only half of the tetrahedral sites are occupied by Zn^{2+} ion
- Stoichiometry of the compound is 1 : 1
- Each Zinc ion is surrounded by four sulphide ions and vice versa
- Coordination number is 4
- Radius ratio is 0.4

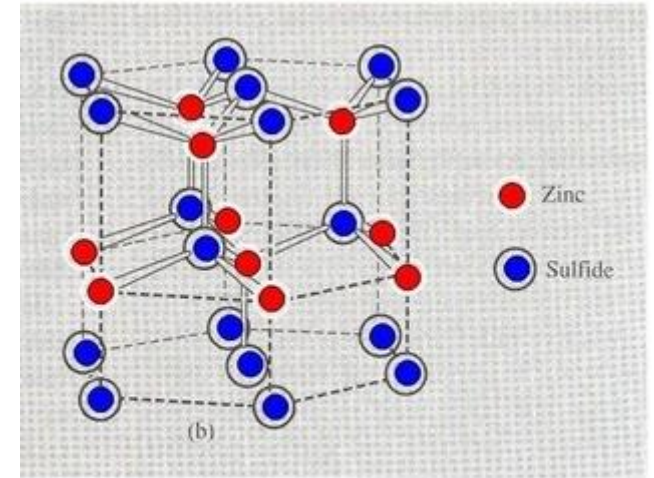

hcp

The Wurtzite Structure

- A structure related to the Zincblende Structure is the **Wurtzite Structure**
- Many semiconductors also have this lattice structure.
- In this structure there is also **Tetrahedral Coordination**
- Each atom has 4 nearest-neighbors. **The Basis set is 2 atoms.**
- **Primitive lattice** \equiv hexagonal close packed (hcp).
2 atoms per hcp lattice point. **A Unit Cell looks like**

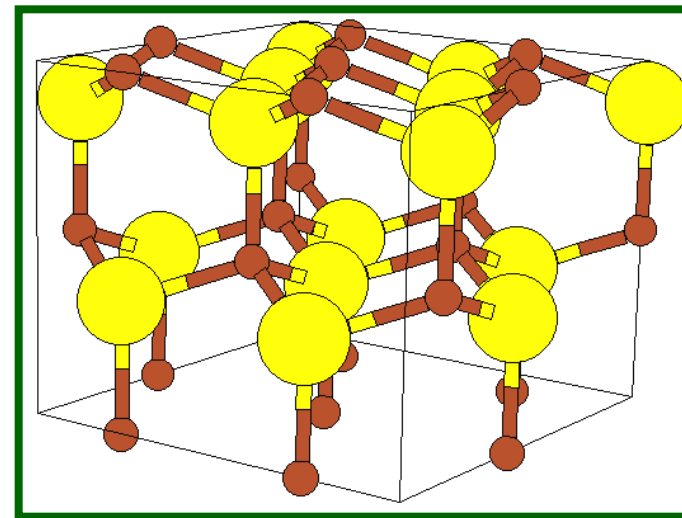
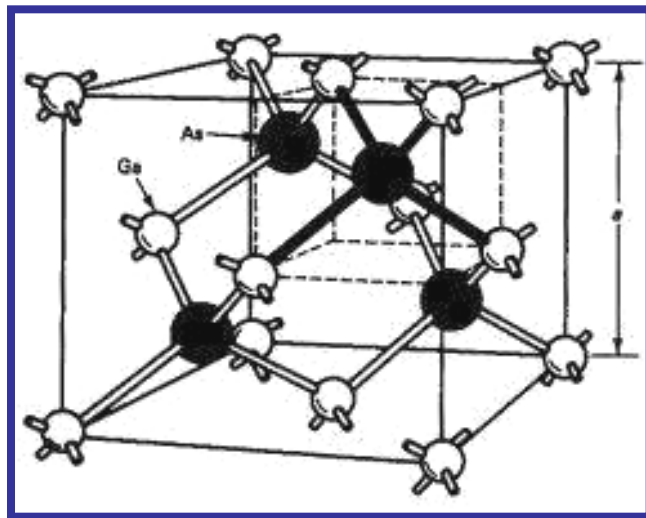

The Wurtzite Lattice

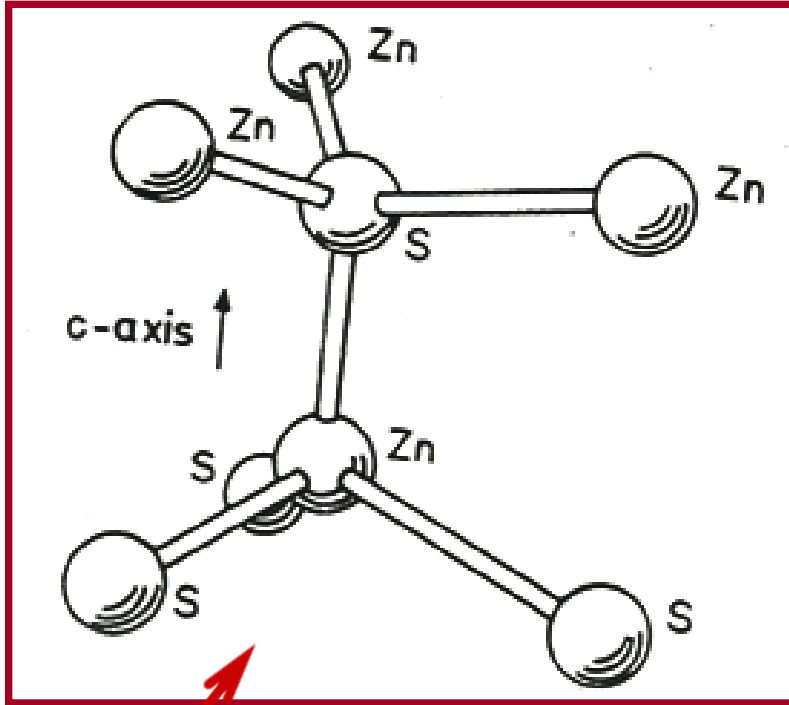

View of **tetrahedral coordination** & **the 2 atom basis**.

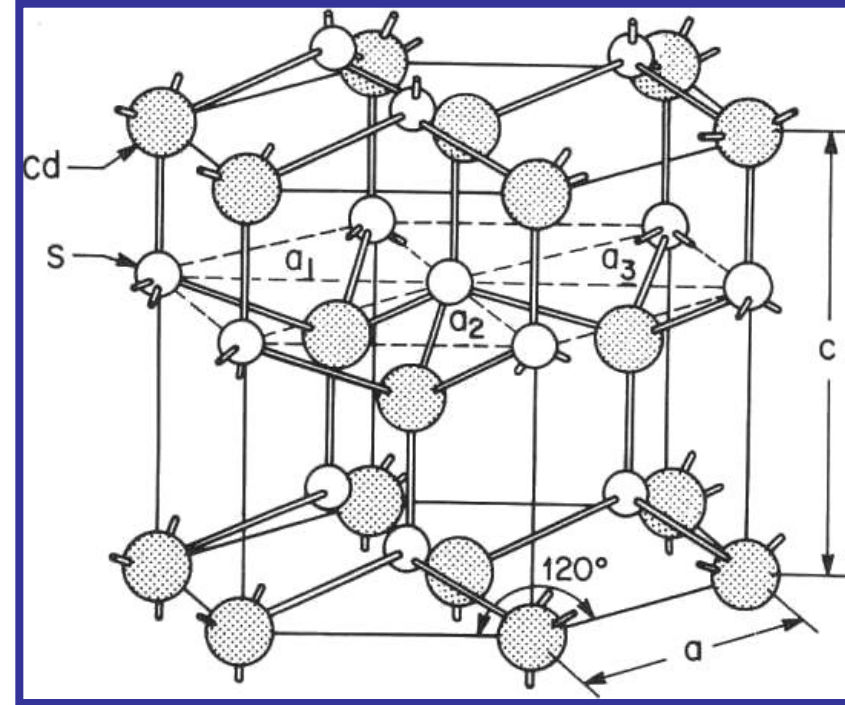

Wurtzite Lattice
≡ Hexagonal Close Packed (HCP)
Lattice + 2 atom basis

Diamond & Zincblende crystals

- The primitive lattice is **FCC**. The **FCC** primitive lattice is generated by $\mathbf{r} = n_1\mathbf{a}_1 + n_2\mathbf{a}_2 + n_3\mathbf{a}_3$.
- The **FCC** primitive lattice vectors are:
 $\mathbf{a}_1 = (\frac{1}{2})a(0,1,0)$, $\mathbf{a}_2 = (\frac{1}{2})a(1,0,1)$, $\mathbf{a}_3 = (\frac{1}{2})a(1,1,0)$
NOTE: The \mathbf{a}_i 's are NOT mutually orthogonal!

Primitive FCC Lattice

cubic unit cell

Diamond:

2 identical atoms per FCC point

Zincblende:

2 different atoms per FCC point

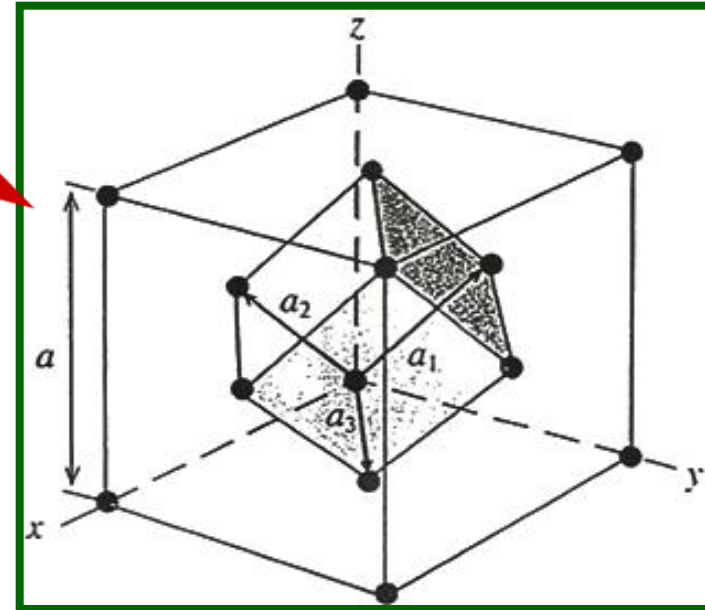

Wurtzite Crystals

- The primitive lattice is **HCP**. The **HCP** primitive lattice is generated by

$$\mathbf{r} = n_1 \mathbf{a}_1 + n_2 \mathbf{a}_2 + n_3 \mathbf{a}_3.$$

- The **hcp** primitive lattice vectors are:

$$\mathbf{a}_1 = c(0,0,1)$$

$$\mathbf{a}_2 = (\frac{1}{2})a[(1,0,0) + (3)^{\frac{1}{2}}(0,1,0)]$$

$$\mathbf{a}_3 = (\frac{1}{2})a[(-1,0,0) + (3)^{\frac{1}{2}}(0,1,0)]$$

NOTE!

These are NOT mutually orthogonal!

Wurtzite Crystals

2 atoms per HCP point

Primitive Lattice Points

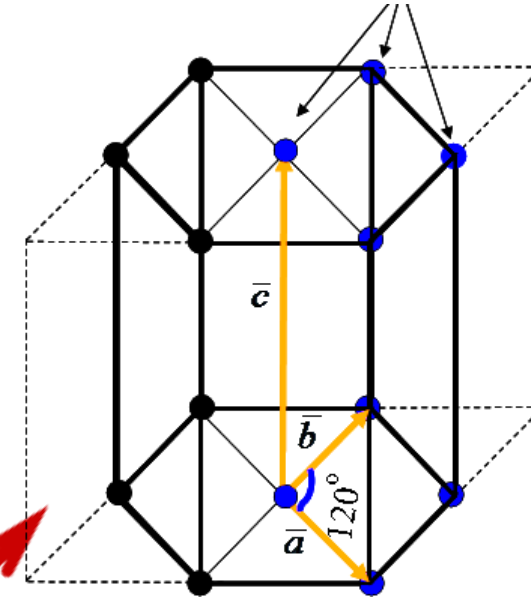

Primitive HCP
Lattice: Hexagonal
Unit Cell

Rutile Structure

- Titanium ions are arranged in a distorted body centered cubic arrangement
- Titanium ions are present at all the corners of the distorted cube
- One of the axes is shorter than the other by 30%
- Each titanium ion is surrounded octahedrally by six oxide ions
- Each oxide ion is surrounded by three titanium ions
- Coordination numbers of Ti^{4+} and O^{2-} are 6 : 3

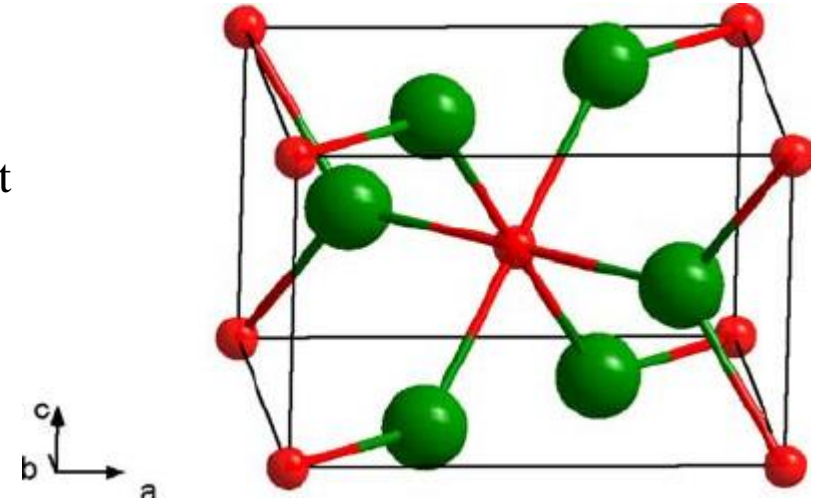

Fluorite Structure

Fluorite (CaF_2)

- Fcc w.r.t cation.
- Tetrahedral sites T_+ and T_- are occupied by anions. Octahedral sites are empty.
- General formula AX_2 .
- CN of anion=4
- CN of cation=8
- It includes fluorides of large, divalent cations and oxides of large tetravalent cations.

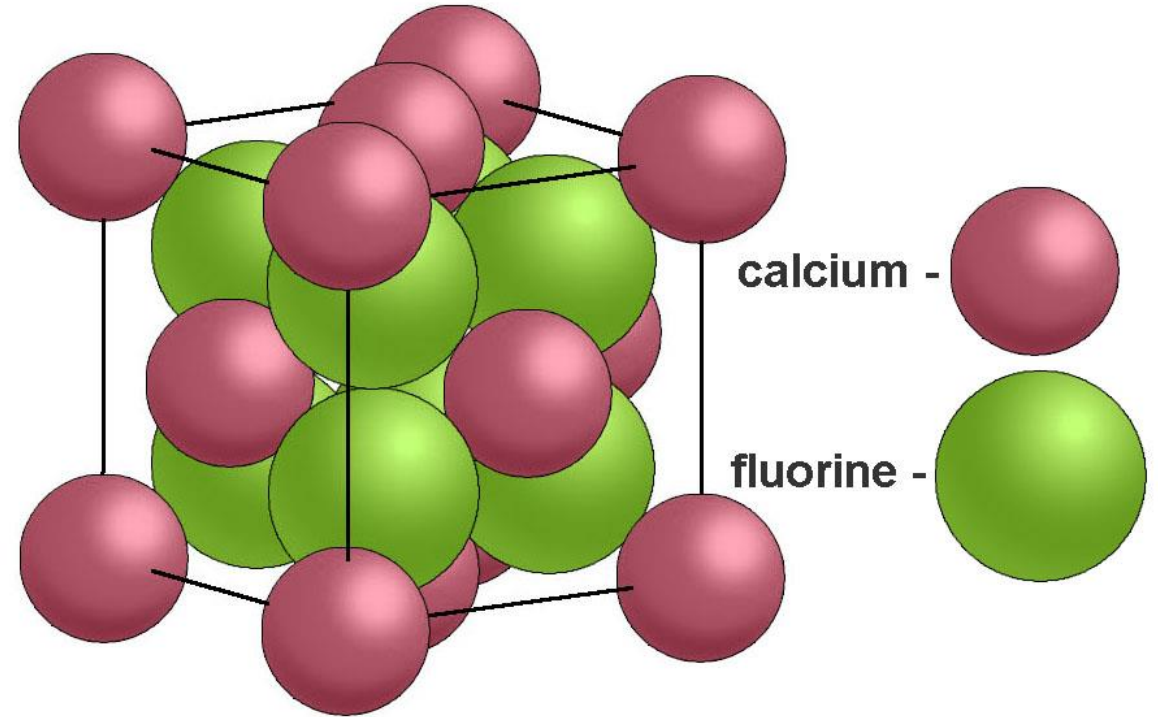

4. Anti-Fluorite (Li_2O)

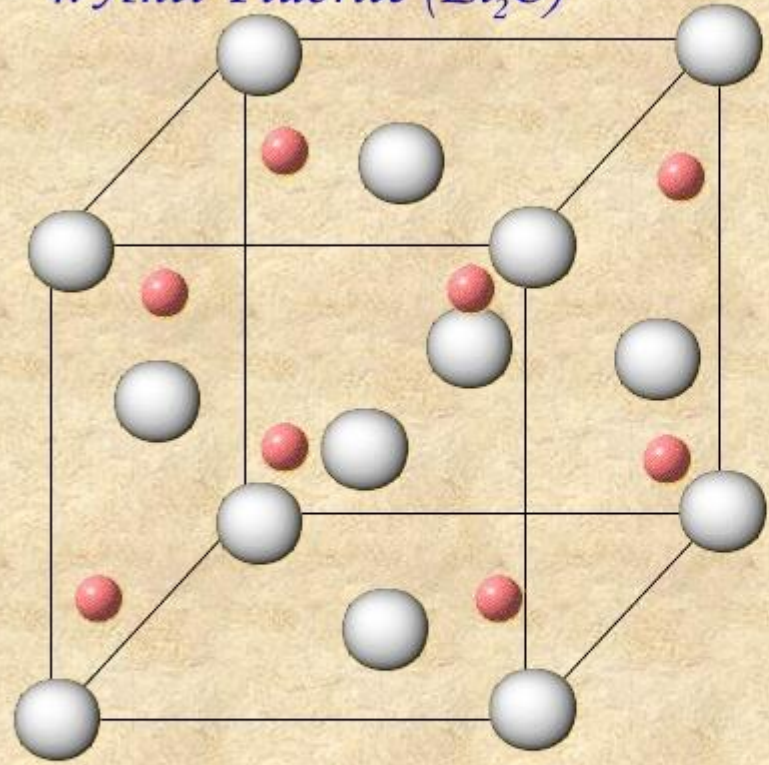

 - O^{2-}

 - Li^+

O^{2-} is FCC

Li^+ occupies all tetrahedral voids

No. of O^{2-} per unit cell = 4

No. of Li^+ per unit cell = 8

\therefore formula is Li_2O

Coordination no. of Li^+ = 4

Coordination no. of O^{2-} = 8

Other compounds which have this structure are: Na_2O , K_2O , Rb_2O

Structures of Ionic Compounds

Antifluorite (Na_2O)

- Fcc w.r.t anions.
- Tetrahedral sites T_+ and T_- are occupied by cations. Octahedral sites are empty.
- General formula A_2X
- CN of anion=8
- CN of cation=4
- Structure shown by oxides and chalcogenides of alkali metals.

Perovskite

- A perovskite is any material with the same type of crystal structure as calcium titanium oxide (CaTiO_3), known as the perovskite structure, or $^{\text{XII}}\text{A}^{2+}\text{VI}^{\text{B}^{4+}}\text{X}^{2-}_3$ with the oxygen in the edge centers.
- The general chemical formula for perovskite compounds is ABX_3 , where 'A' and 'B' are two cations of very different sizes, and X is an anion that bonds to both.
- The 'A' atoms are larger than the 'B' atoms.
- The ideal cubic structure has the B cation in 6-fold coordination, surrounded by an octahedron of anions, and the A cation in 12-fold cuboctahedral coordination.
- The relative ion size requirements for stability of the cubic structure are quite stringent, so slight buckling and distortion can produce several lower-symmetry distorted versions, in which the coordination numbers of A cations, B cations or both are reduced.

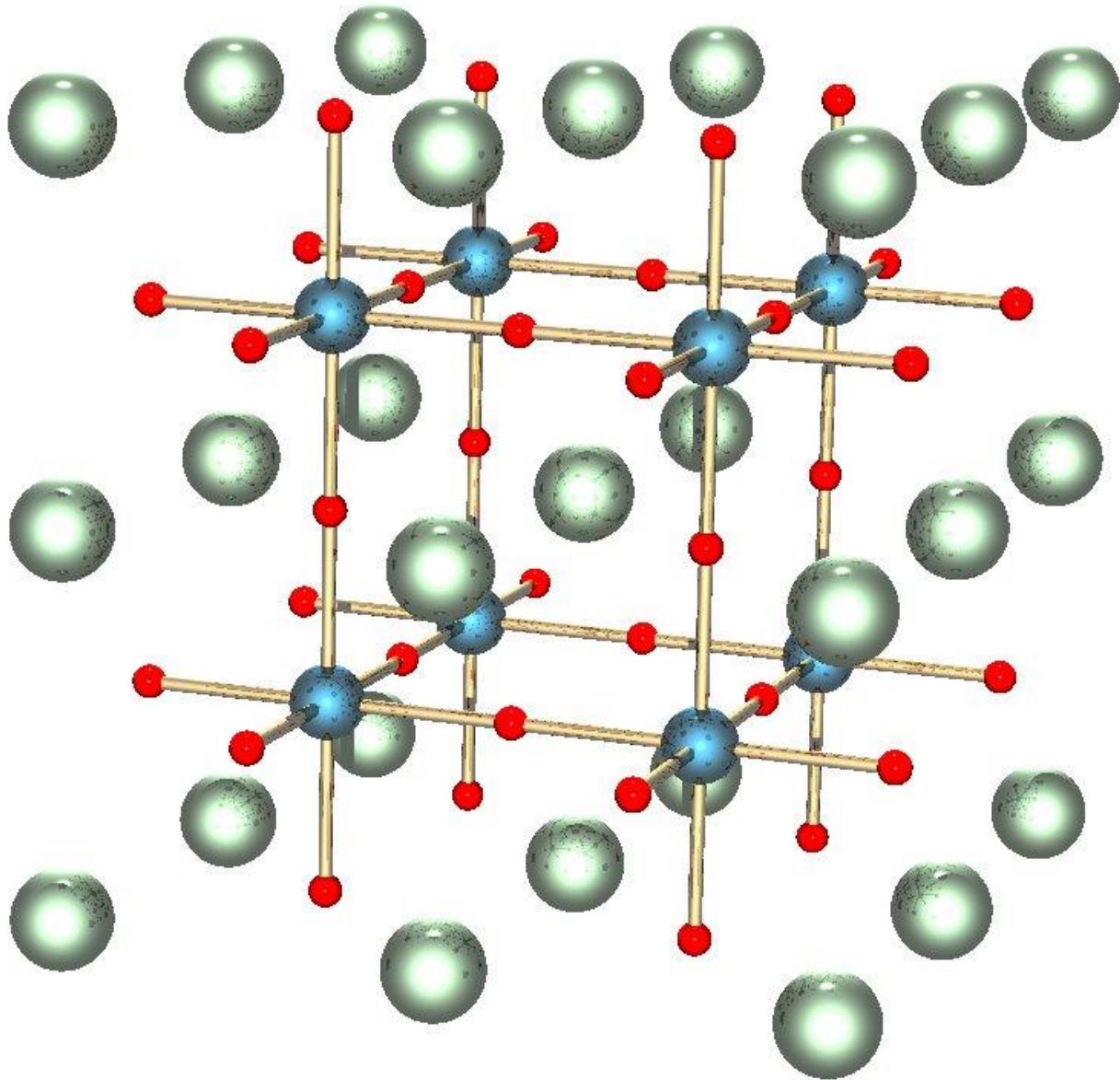

- Structure of a perovskite with general chemical formula ABX_3 .
- Red spheres are X atoms (usually oxygens),
- Blue spheres are B atoms (a smaller metal cation, such as Ti^{4+}),
- Green spheres are the A atoms (a larger metal cation, such as Ca^{2+}).
- Pictured is the undistorted [cubic](#) structure; the symmetry is lowered to [orthorhombic](#), [tetragonal](#) or [trigonal](#) in many perovskites

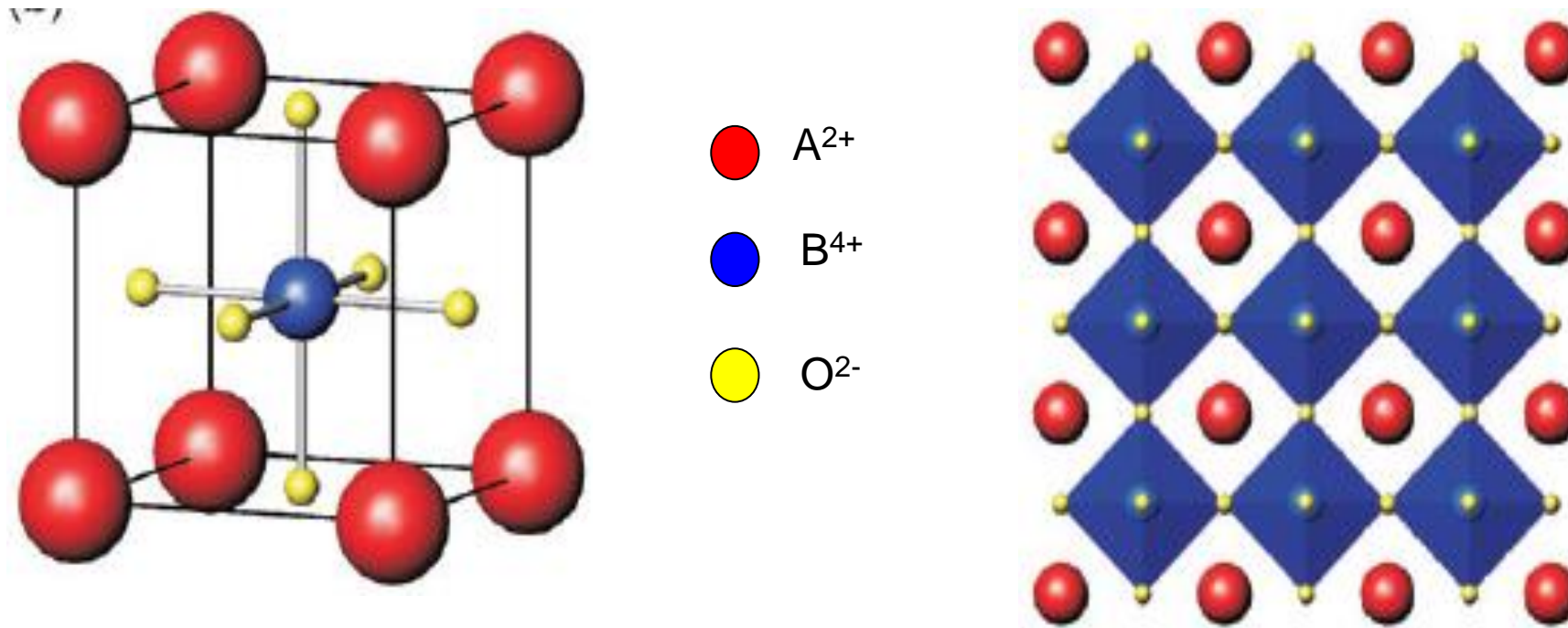

Ideal cubic perovskite structure (ABO_3)

- Very stable structure, large number of compounds, variety of properties, many practical applications.
- Key role of the BO_6 octahedra in ferromagnetism and ferroelectricity.
- Extensive formation of solid solutions → material optimization by composition control and phase transition engineering.

Perovskite - an Inorganic Chameleon

ABX_3 - three compositional variables, A, B and X

- CaTiO_3 - dielectric
- BaTiO_3 - ferroelectric
- $\text{Pb}(\text{Mg}_{1/3}\text{Nb}_{2/3})\text{O}_3$ - relaxor ferroelectric
- $\text{Pb}(\text{Zr}_{1-x}\text{Ti}_x)\text{O}_3$ - piezoelectric
- $(\text{Ba}_{1-x}\text{La}_x)\text{TiO}_3$ - semiconductor
- $(\text{Y}_{1/3}\text{Ba}_{2/3})\text{CuO}_{3-x}$ - superconductor
- Na_xWO_3 - mixed conductor; electrochromic
- SrCeO_3 - H - protonic conductor
- RECoO_{3-x} - mixed conductor
- $(\text{Li}_{0.5-3x}\text{La}_{0.5+x})\text{TiO}_3$ - lithium ion conductor
- LaMnO_{3-x} - Giant magneto-resistance

In SrTiO_3 , Ti-O $\sim 1.95 \text{ \AA}$ a typical bond length for Ti-O; stable as a cubic structure



larger

In BaTiO_3 , Ti-O is stretched, $> 2.0 \text{ \AA}$ Too long for a stable structure.

Ti displaces off its central position towards one oxygen

→ square pyramidal coordination

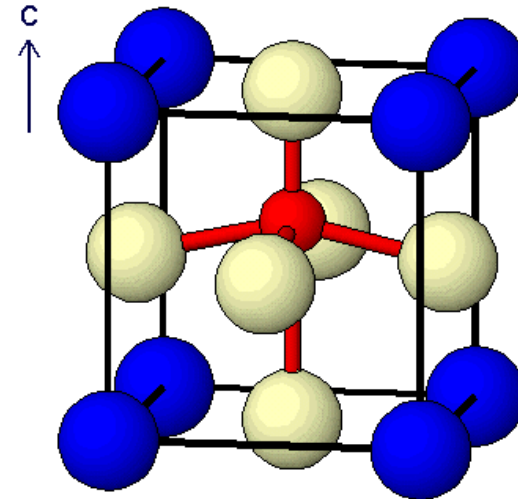
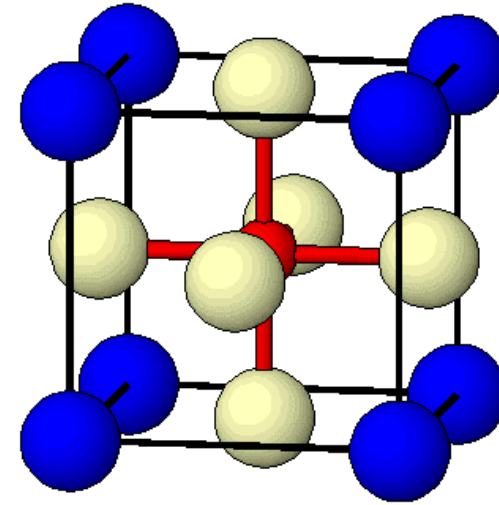

This creates a net dipole moment :

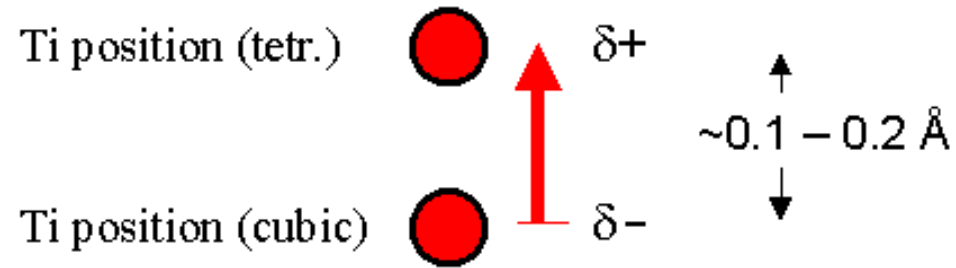

Displacement by 5-10% Ti-O bond length

Random dipole orientations

paraelectric

Aligned dipole orientations

ferroelectric

Under an applied electric field, dipole orientations can be reversed, i.e. the structure is *polarisable*

Dipoles tend to be 'frozen in' at room temperature; as increase temperature, thermal vibrations increase the polarisability

Superconductors

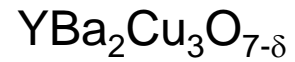

Perovskite?

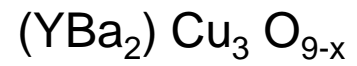

Oxygen Deficient

Triple Perovskite

Crosses mark absent
oxygens

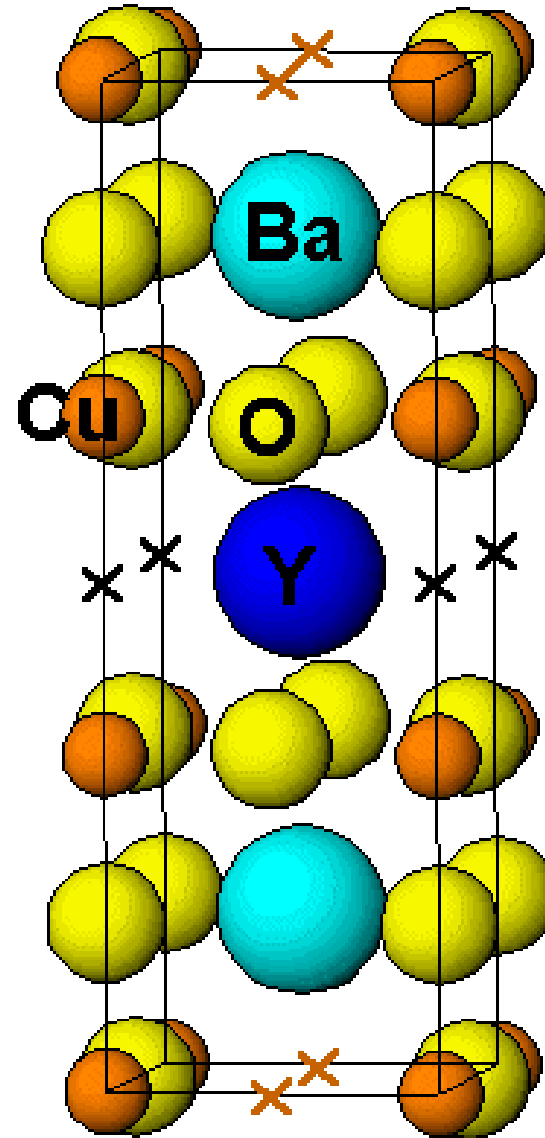

Properties



superconductor

- resistance lost completely at temperature T_c

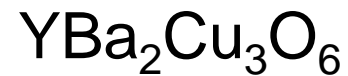

semiconductor

- oxygen lost from base of unit cell

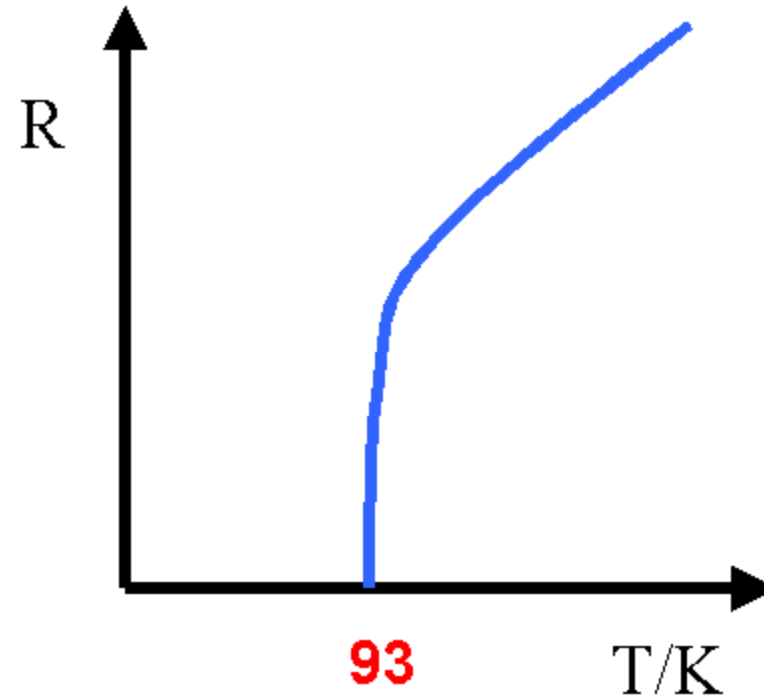

Properties



superconductor

- perfect diamagnet (excludes a magnetic field)

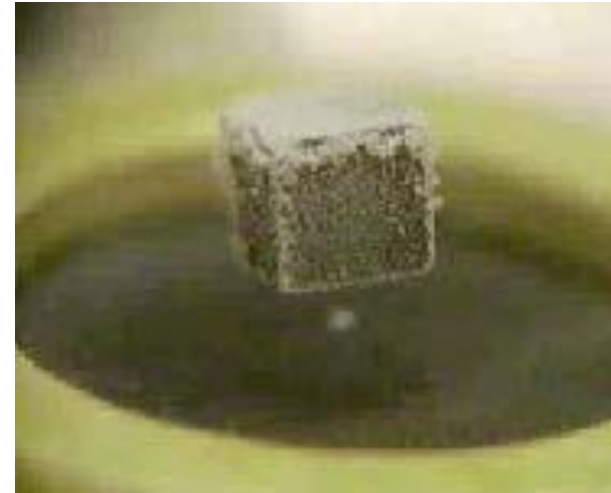

[Magnetic levitation](#)

- http://www.youtube.com/watch?v=hksy_4Zmh80
- <http://www.realboring.com/floating-magnet/> Alert!

Properties

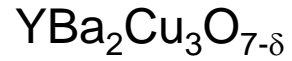

As δ increases:

- 1) T_c decreases
- 2) symmetry changes from orthorhombic to tetragonal (oxygen atoms rearrange in base)

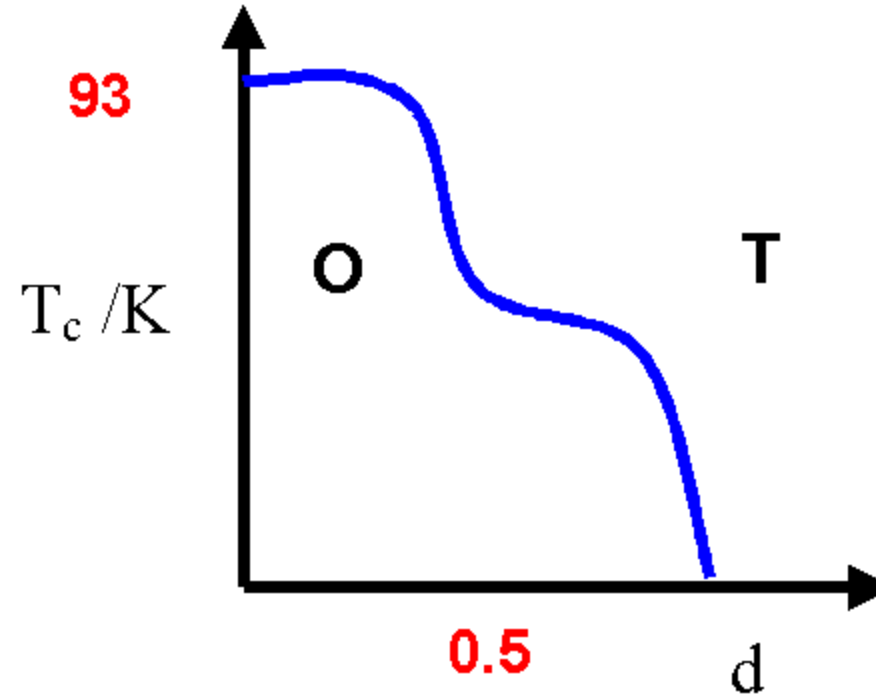

O = orthorhombic, T = tetragonal

APPLICATION

► Perovskites solar cells:

A perovskite solar cell is a type of solar cell which includes a perovskite absorber.

This act as the light-harvesting active layer, which produces electricity from sunlight.

Perovskite absorber materials are extremely cheap to produce and simple to manufacture

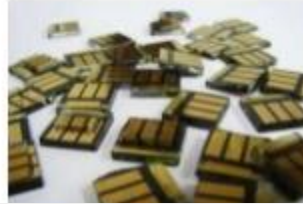

Lasers

► In 2014 researchers demonstrated that perovskite can generate laser light

► **Methyl ammonium lead iodide perovskite** ($\text{CH}_3\text{NH}_3\text{PbI}_{3-x}\text{Cl}_x$) cells fashioned into optically pumped **vertical-cavity surface-emitting lasers (VCSELs)** convert visible pump light to near-IR laser light with a **70% efficiency**.

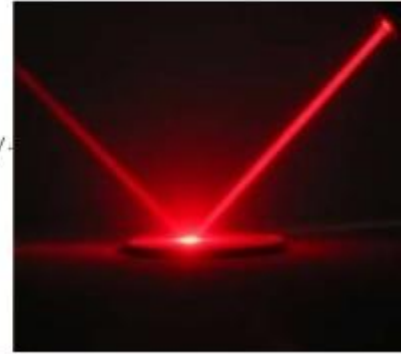
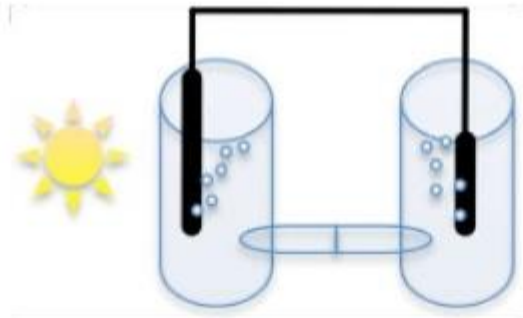

Photo electrolysis

► Water electrolysis at **12.3%** efficiency in a highly efficient and low-cost water-splitting cell using **perovskite photovoltaics**



PEROVSKITE MATERIALS: **STRUCTURE-PROPERTY-FUNCTION-UTILITY RELATIONS**

- **LiNbO₃** non-linear optical ferroelectric - E-field RI control - electrooptical switch
- **SrTiO₃** dye sensitized semiconductor liquid junction photocathode - solar cell
- **H_xWO₃** proton conductor - hydrogen/oxygen fuel cell electrolyte
- **BaY₂Cu₃O₇** high T_c superconductor - magnetic levitation - detector/SQUIDS
- **BaTiO₃** ferroelectric high dielectric capacitor, photorefractive – holography
- **Ca_xLa_{1-x}MnO₃** x control F-metal, P-semiconductor - GMR - data storage
- **Sr_xLa_{1-x}MnO₃** x control e⁻/oxide ion conductor - solid oxide fuel cell cathode
- **PbZr_xTi_{1-x}O₃** piezoelectric - oscillator, nano-positioner

Ilmenite ABO_3 ($FeTiO_3$)

- Approximate close packed array of oxide ions with cations with 2/3 of the octahedral site
- Ilmenite structure is adopted by mixed transition metal oxides, $FeTiO_3$, $NiTiO_3$ and $CoTiO_3$
- More stable titanium ion has a charge of +4, the other transition metal ions are divalent
- Average metal valency is +3, same as the valency of Fe in Fe_2O_3
- Cations are segregated so that there are alternate layers of A and B Cations
- The ilmenite crystal structure consists of an ordered derivative of the corundum structure;
- In corundum all cations are identical but in ilmenite Fe^{2+} and Ti^{4+} ions occupy alternating layers perpendicular to the trigonal c axis.
- Containing high spin ferrous centers, ilmenite is paramagnetic.

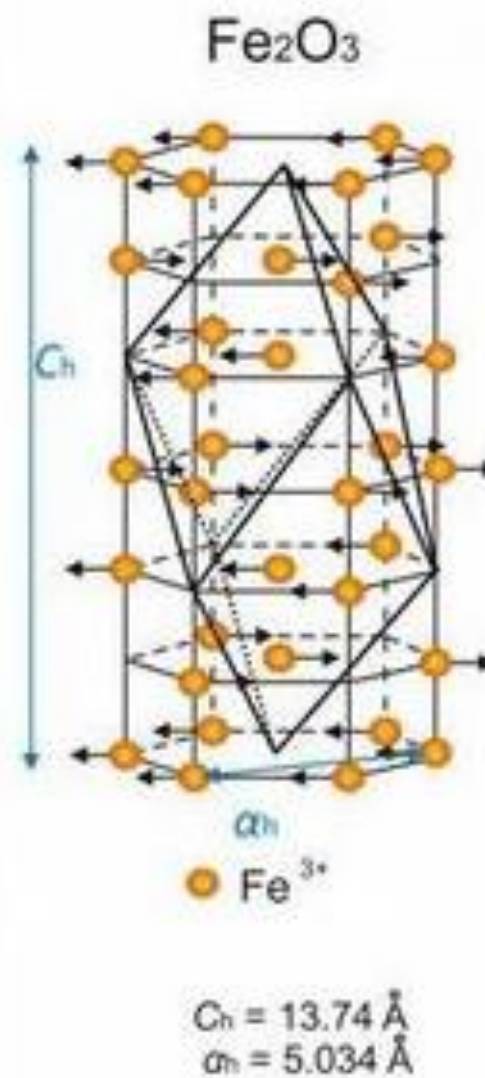
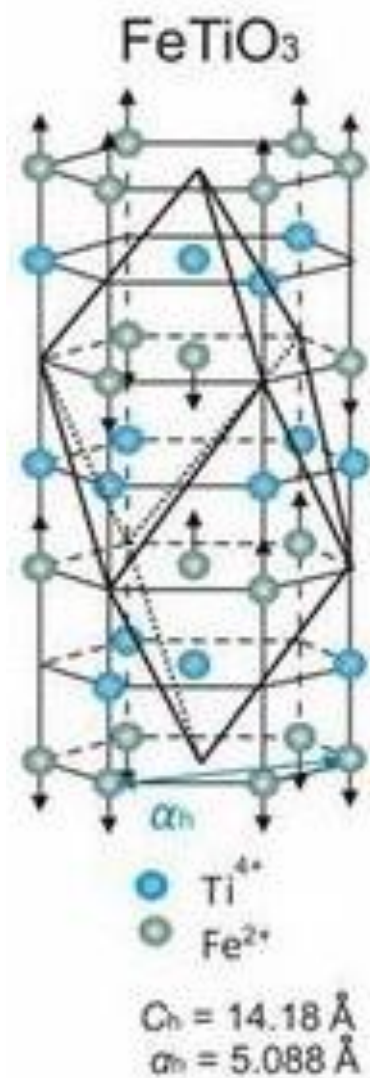
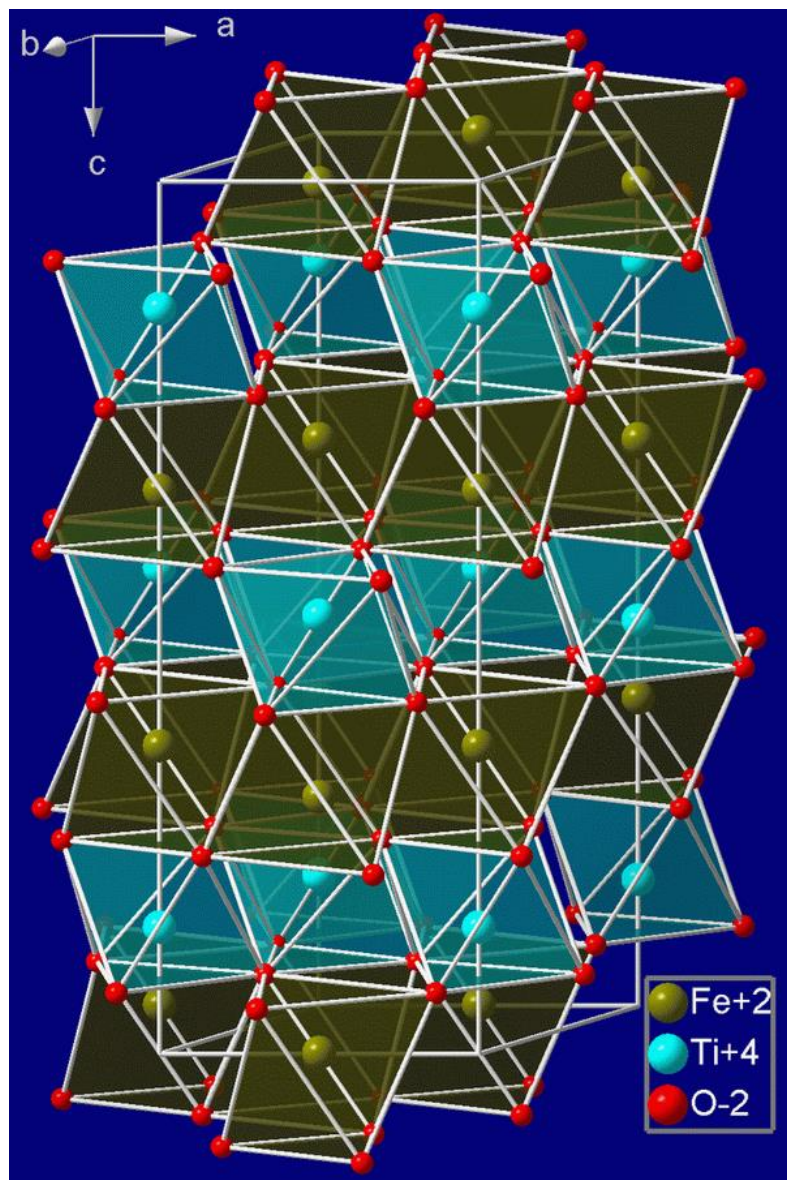

SPINELS



- Mixed metal oxides.
- Cubic close packed system, cubic sites occupied by oxide ligand, which are weak field ligands.
- Contain tetrahedral and octahedral holes Based on type of metal atom occupying them, they are classified into two types
 - i. Normal Spinels
 - ii. Inverse Spinels or antispinels

Normal Spinels

- » Bivalent ions occupy tetrahedral sites, trivalent ions occupy octahedral sites.
- » General Formula :
- » $A^{+2}B_2^{+3}O_4$ OR $(A^{II})^{tet}(B^{III})_2^{oct}O_4$
- » E.g Mn_3O_4 (i.e $Mn^{+2}Mn_2^{+3}O_4$)
- » $MgAl_2O_4$ (known as spinel), $ZnFe_2O_4$, $FeCr_2O_4$ (chromite) etc.

NOTATIONS

- » A^{+n} represents a metal atom of charge +n occupying a tetrahedral site.
- » B^{+m} represents a metal atom of charge +m occupying an octahedral site.

Inverse Spinels

- » All bivalent cations and half the trivalent cations in octahedral holes. The other half of trivalent cations are in tetrahedral holes.
- » General Formula $B^{+2}B^{+3}A^{+3}O_4$ or $(B^{II})^{oct}(B^{III})^{oct}(A^{III})^{tet}O_4$

Spinel



- Spinel generally refer to metal oxides having general formula AB_2X_4
- The spinel that is most popularly known is $MgAl_2O_4$

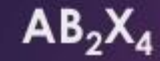

► Where

A^{II} = a **divalent cation** like Mg, Cr, Mn, Fe, Co, Ni, Cu, Zn, Cd, Sn

B^{III} = a **trivalent cation** like Al, Ga, In, Ti, V, Cr, Mn, Fe, Fe, Co, Ni

X = O, S, Se etc.

Crystal Structure of Spinel

Normal spinel structures are usually cubic close-packed oxides with one octahedral and two tetrahedral sites per formula unit.

B^{3+} ions occupy half the octahedral holes, while A^{2+} ions occupy one-eighth of the tetrahedral holes.

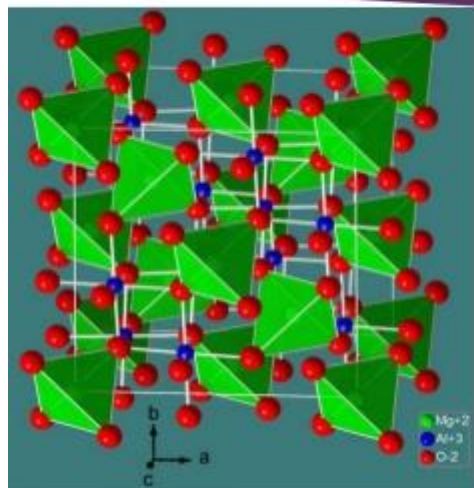

Examples In_4SnS_8 and $MgAl_2O_4$

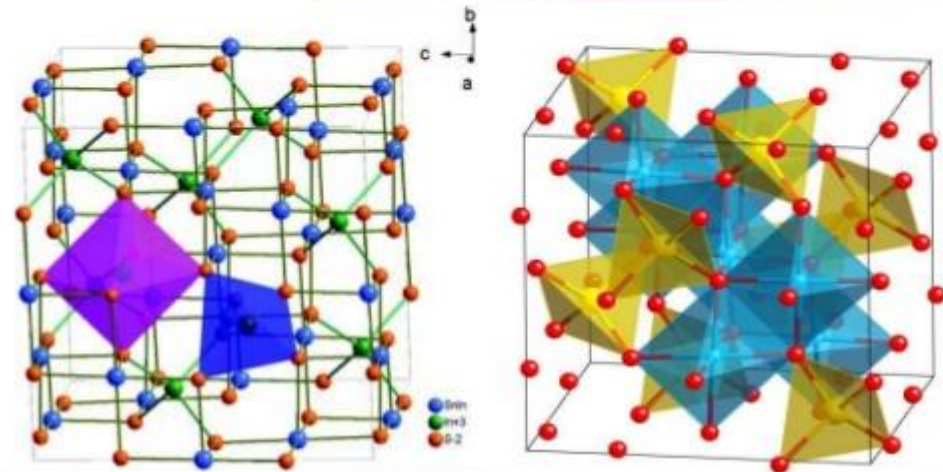

OTHER EXAMPLES:
 Mn_3O_4 , $ZnFe_2O_4$,
 $FeCr_2O_4$
(chromite) etc

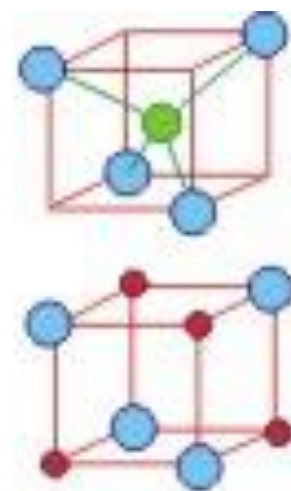
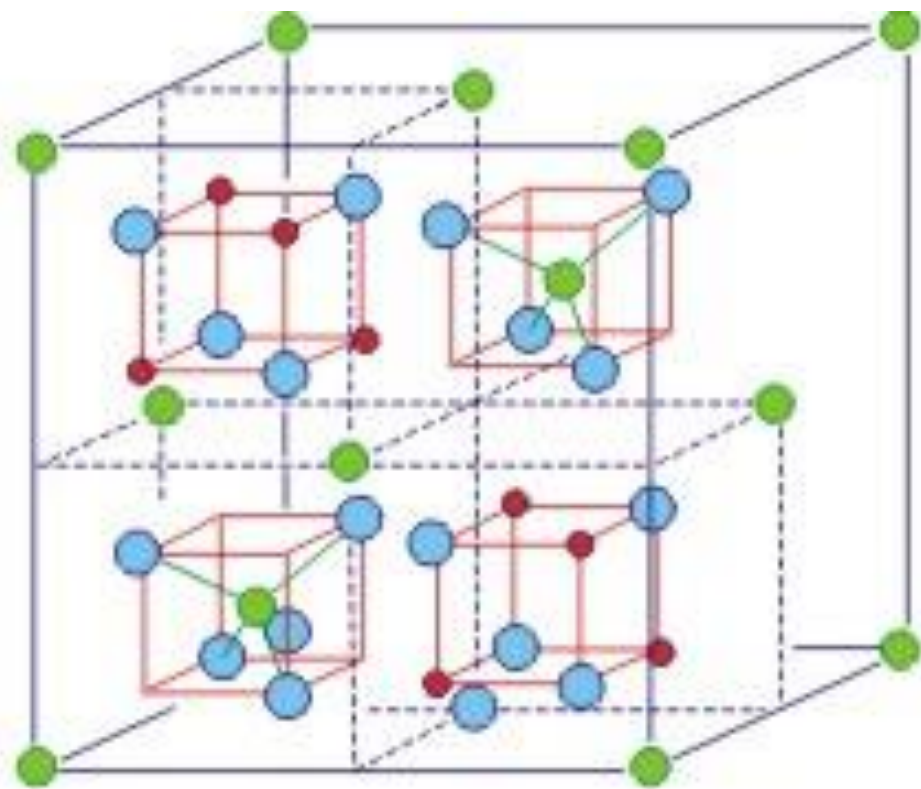

- Oxygen
- B-atoms
octahedral sites
- A-atoms
tetrahedral sites

AB₂O₄ spinel The red cubes are also contained in the back half of the unit cell.

Presence of Cations

- ▶ Let us consider the case of **ZnCr₂O₄**

Zn +2 d-10 ion with CFSE = 0 and thus, there will be no effect on Oh holes.

Cr +3 d-3 ion with CFSE = -8Dq and hence this cations will occupy the Oh holes.

Hence **higher** the CFSC value, greater is its tendency to occupy octahedral hole.

Applications

- ▶ Due to greater refractive index, spinels are generally used as Gemstones. These spinel gemstones are considered very rare and precious.

Timur Ruby



398.72-carat

Catherine the Great's ruby



Black Prince's ruby

Other Applications

- ▶ Spinel is generally used in TV and Phone screens.

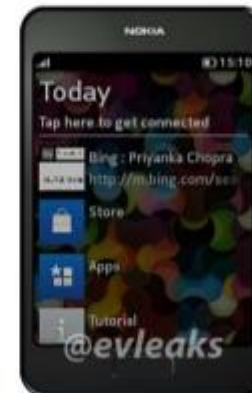

Super magnets

- ▶ Used as superconducting magnet in MRI and NMR

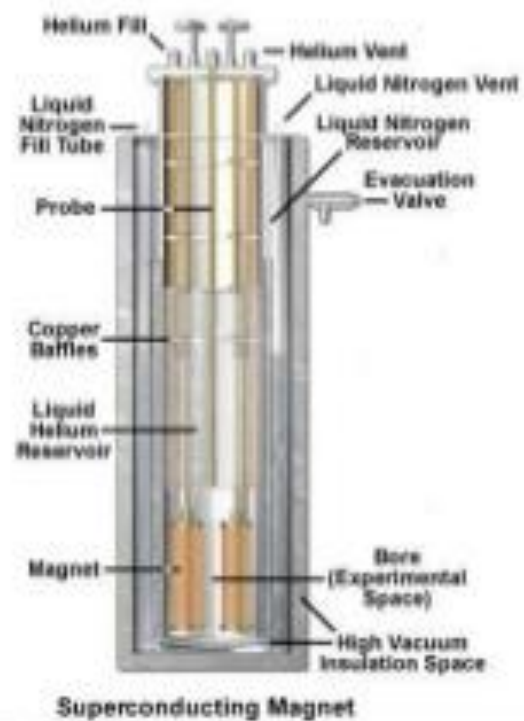

Inverse Spinel

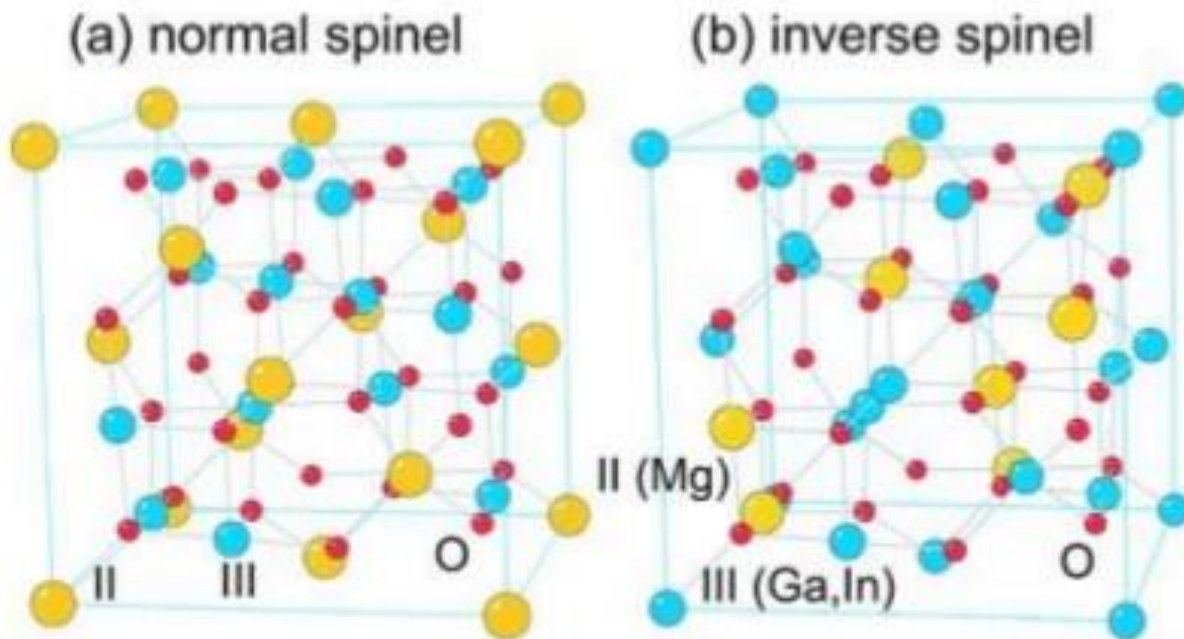

This picture compares the crystal structure of **inverse Spinel** with **spinel**.

STRUCTURAL ARRANGEMENT

- ▶ Inverse Spinel usually have alternate arrangement.
- ▶ The **A^{II}** ions occupy the **octahedral** voids, whereas half of **B^{III}** ions occupy the **tetrahedral** voids
- ▶ It can be represented as: $(B^{III})^{tet}(A^{II}B^{III})^{oct}O_4$
- ▶ Most ferrite follow this structure such as Fe_3O_4 (or $FeO \cdot Fe_2O_3$), $NiFe_2O_4$, $CoFe_2O_4$ etc

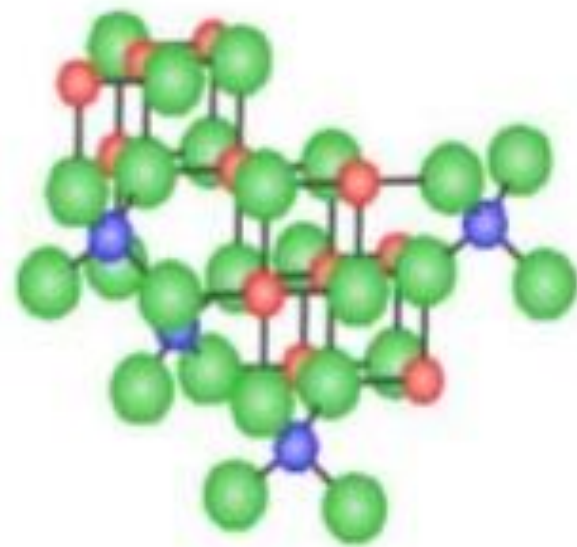

Magnetite, an inverse spinel
 Fe_3O_4 , or $Fe(FeO)_2$

- octahedral Fe(II,III)
- tetrahedral Fe(III)
- oxide anion

CONCLUSION

Normal Spinel $A_{tet}(M_2)_{oct}X_4$

eg. spinel, $MgAl_2O_4$



A

Mg^{2+} (tetrahedral)



M

Al^{3+} (octahedral)



X

O^{2-}

Inverse Spinel $M_{tet}A_{oct}M_{oct}X_4$

eg. magnetite, Fe_3O_4

Fe^{3+} (tetrahedral)

Fe^{2+}, Fe^{3+} (octahedral)

O^{2-}

Diffusion in Solids

INTRODUCTION

- Diffusion is the movement of atoms within a material. Atoms move in a predictable fashion to eliminate concentration differences and produce homogeneous, uniform composition. These movements are required for many of the treatments that we perform on materials.
- Diffusion is required for the heat treatment of metals, the manufacture of ceramics, the manufacture of transistor and solar cells.

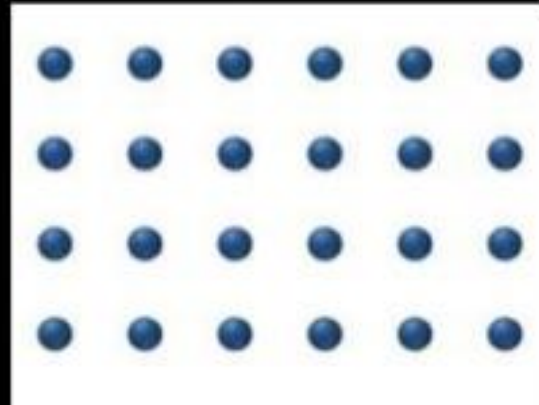

Interstitial Atomic diffusion across a 4-coordinated lattice.

Diffusion Phenomena

- Diffusion is a process of mass transport by atomic movement under the influence of thermal energy and a concentration gradient.
- Atoms move from higher to lower concentration region.
- If this movement is from one element to another e.g. Cu to Ni, then it is termed *inter-diffusion*. If the movement is within similar atoms as in pure metals, it is termed *self-diffusion*.

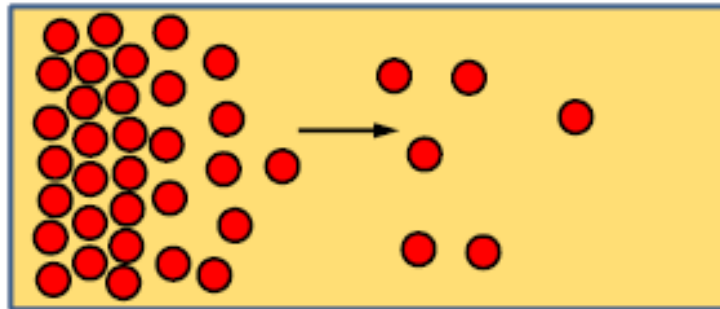

DIFFUSION MECHANISM

- There are four important mechanisms by which atoms diffuse:
 - ❑ Self Diffusion
 - ❑ Interchange Diffusion
 - ❑ Vacancy Diffusion
 - ❑ Interstitial Diffusion

Atomic Diffusion Mechanisms

- **Vacancy Diffusion** – In self-diffusion and diffusion involving substitutional atoms, an atom leaves its lattice site to fill a nearby vacancy (thus creating a new vacancy at the original lattice site). As the diffusion continues, we have a countercurrent flow of atoms and vacancies.
- **Interstitial Diffusion** – When a small interstitial atom is present in the crystal structure, the atom moves from one interstitial site to another. **No vacancies are required. Interstitial diffusion is generally faster than vacancy diffusion because bonding of interstitials to the surrounding atoms is normally weaker and there are many more interstitial sites than vacancy sites to jump to.** Requires small impurity atoms (e.g. C, H, O) to fit into interstices in host.
- **Interstitialcy Diffusion** – When a “normal” atom occupies an interstitial site in the crystal, it moves from one interstitial site to another. Normally this is not a common method of diffusion except when irradiation damage occurs, which happens when semiconductor materials are doped with foreign atoms and in nuclear reactors when high-energy neutrons pass through materials.
- **Exchange and Ring Diffusion** – Atoms are always vibrating and can exchange position with their adjacent neighbor or many atoms can rotate in unison around in a ring fashion.

Motion of atom →

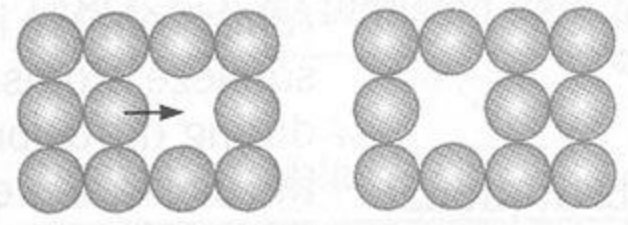

← Motion of vacancy

(a) Vacancy mechanism

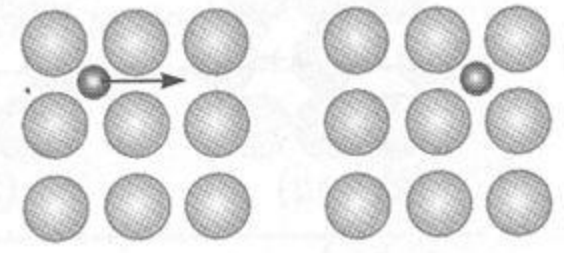

(b) Interstitial mechanism

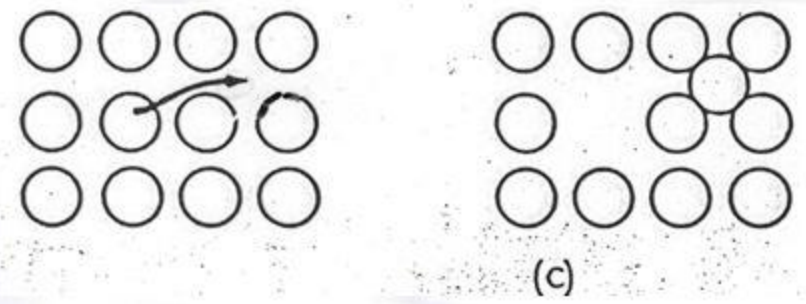

Interstitialcy diffusion (This is energetically unfavorable so is very rare)

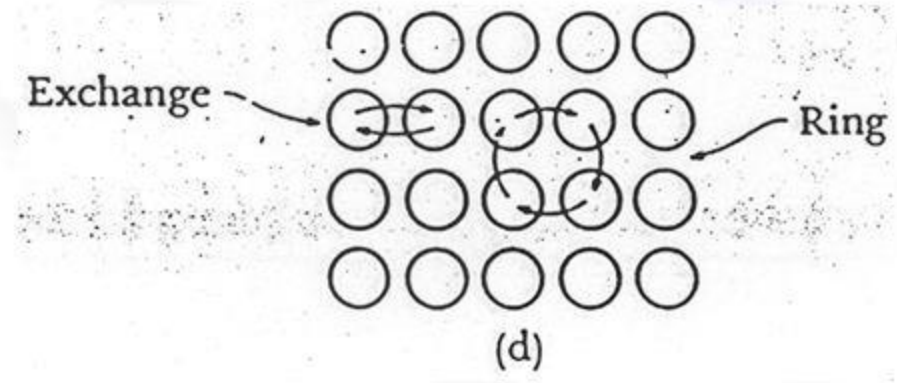

Ring diffusion

DIFFUSION MECHANISM

SELF-DIFFUSION (SUBSTITUTIONAL)

- Even in absolutely pure solid materials, atoms move from one lattice position to another. This process, known as self-diffusion, can be detected by using radioactive tracers. Although self-diffusion occurs continually in all materials, the effect on the material's behaviour is not significant.



Diffusion Mechanism

- Diffusion of atoms involves movement in steps from one lattice site to the another. An empty adjacent site and breaking of bonds with the neighbor atoms are the two necessary conditions for this.

Vacancy Diffusion

- This mechanism involves movement of atoms from a regular lattice site to an adjacent vacancy. Since vacancy and atoms exchange position, the vacancy flux is in the opposite direction.

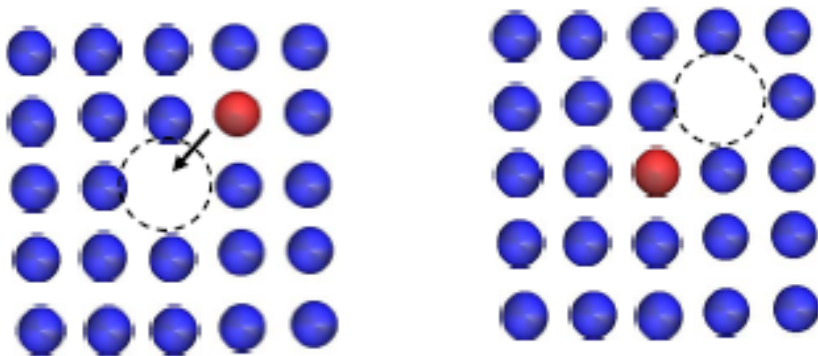

Diffusion Mechanism

Interstitial Diffusion

- This mechanism involves migration of atoms from one interstitial site to a neighbouring empty interstitial site.
- This mechanism is more prevalent for impurity atoms such as hydrogen, carbon, nitrogen, oxygen which are small enough to fit in to an interstitial position.
- For substitutional diffusion atoms exchange their places directly or along a ring (ring diffusion mechanism).

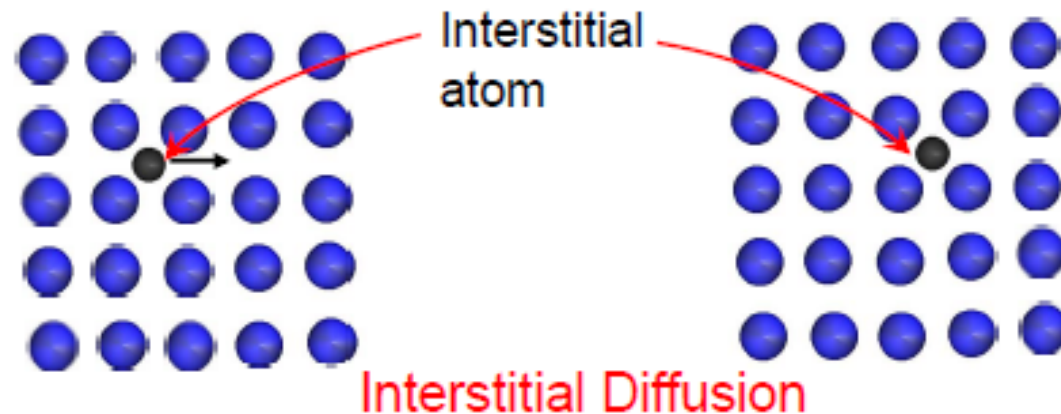

Kirkendall Effect

➤ If the diffusion rates of two metals A and B in to each other are different, the boundary between them shifts and moves towards the faster diffusing metal as shown in the figure.

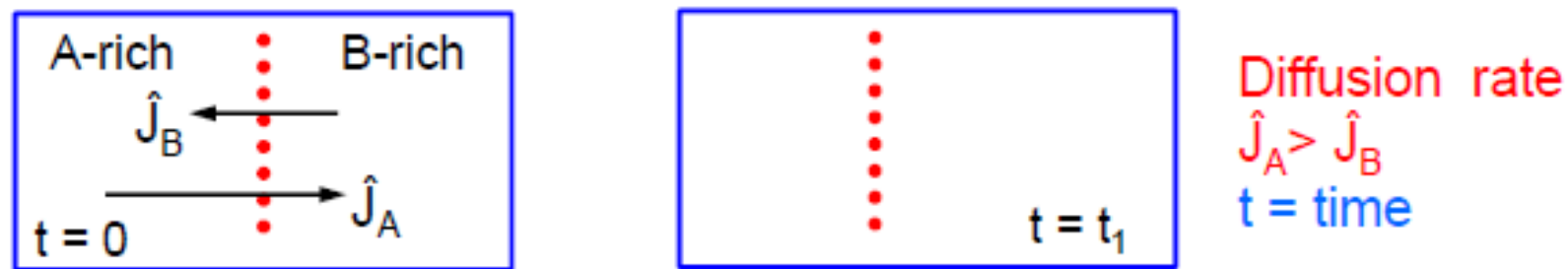

- This is known as Kirkendall effect. Named after the inventor Ernest Kirkendall (1914 – 2005).
- It can be demonstrated experimentally by placing an inert marker at the interface.
- This is a direct evidence of the vacancy mechanism of diffusion as the other mechanisms do not permit the flux of diffusing species to be different.

Kirkendall effect

➤ Zn diffuses faster into Cu than Cu in Zn. A diffusion couple of Cu and Zn will lead to formation of a growing layer of Cu-Zn alloy (Brass).

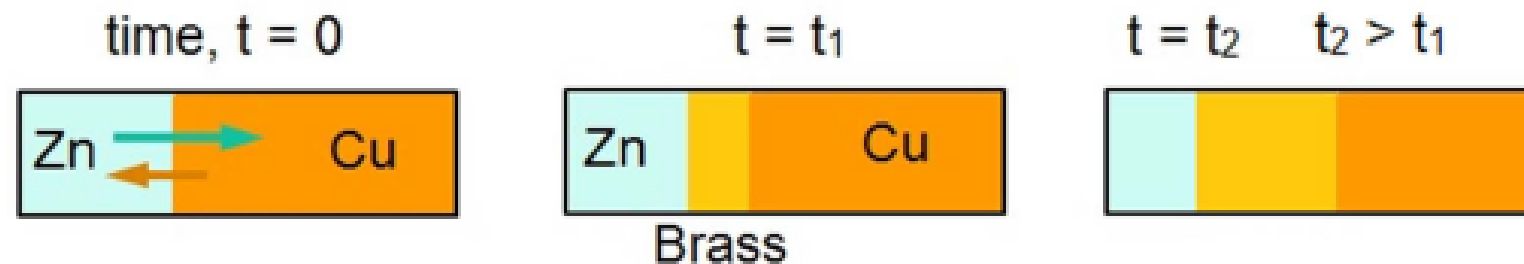

➤ Same will happen in a Cu-Ni couple as Cu diffuses faster in Ni than vice versa.

➤ Since this takes place by vacancy mechanism, pores will form in Cu (of the Cu-Ni couple) as the vacancy flux in the opposite direction (towards Cu) will condense to form pores.

Fick's Law

Steady-state diffusion

- Steady-state diffusion is the situation when the diffusion flux is independent of time (e.g. diffusion of a gas through solid medium where concentration/pressure of the gas is kept constant at both the end).
- Fick's first law describes steady-state diffusion and is given by

$$J = -D \frac{dC}{dx}$$

Where, J is the diffusion flux or the mass transported per unit time per unit area and dC/dx is the concentration gradient. D is known as the diffusion coefficient.

Fick's Second Law

Non- Steady state diffusion

- In most practical situations, diffusion is non-steady state i.e. diffusion flux and concentration gradient varies with time.
- This is described by Fick's second law

$$\frac{\partial C}{\partial t} = D \frac{\partial^2 C}{\partial x^2}$$

- A solution to this equation can be obtained for a semi-infinite solid with the following boundary conditions.
For $t = 0$, $C = C_0$ at $0 \leq x \leq \infty$. For $t > 0$, $C = C_s$ (surface concentration) at $x = 0$ and $C = C_0$ at $x = \infty$

$$\frac{C_x - C_0}{C_s - C_0} = 1 - \operatorname{erf}\left(\frac{x}{2\sqrt{Dt}}\right)$$

The more generalized form is $C_x = C(x, t) = A - B \operatorname{erf}\left(\frac{x}{2\sqrt{Dt}}\right)$

Interstitialcy Mechanism

- Both interstitial and normal sites are involved
- A knock on process occurs
- Cation causes one of its neighbouring cations to move off its normal site into an adjacent interstitial site and itself occupies the vacant lattice site thereby created

Diffusion mechanisms in Si: substitutional and interstitialcy

Si native point defects required (Si vacancy and Si interstitials); Examples: B, P, As, Sb.

a) Substitutional diffusion

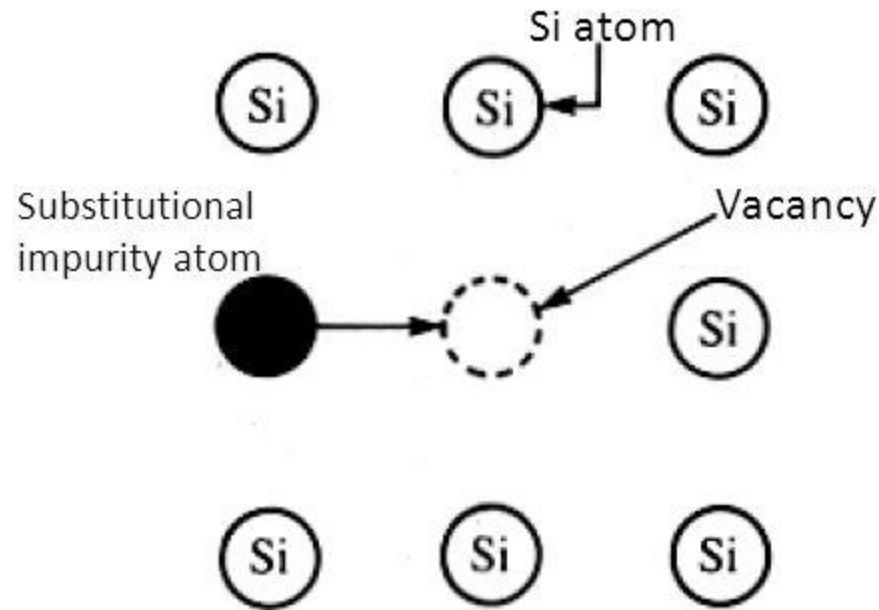

b) Interstitialcy diffusion

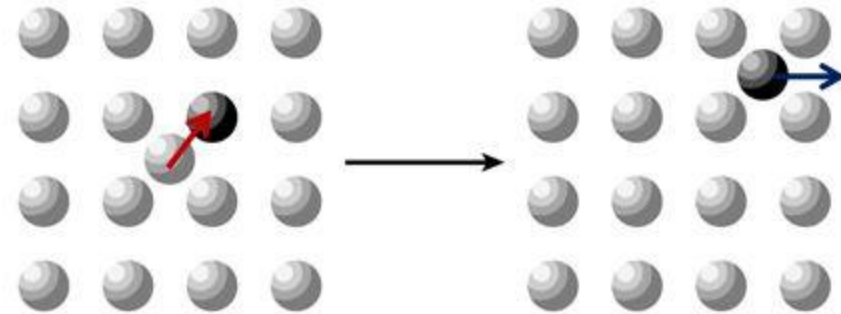
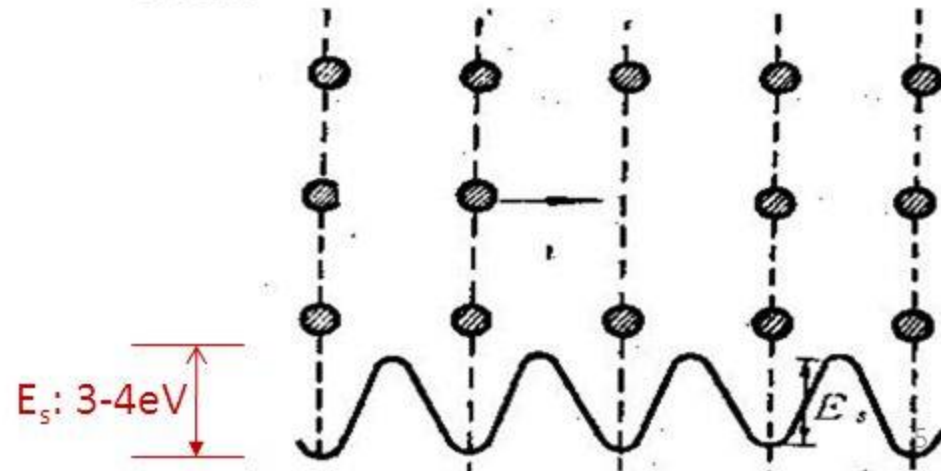

Figure 3.5 In interstitialcy diffusion an interstitial silicon atom displaces a substitutional impurity, driving it to an interstitial site where it diffuses some distance before it returns to a substitutional site.

“Hopping” frequency:

$$P_v = \exp\left(-\frac{E_{vac}}{kT}\right) \cdot v_0 \exp\left(-\frac{E_s}{kT}\right)$$
$$= v_0 \exp\left(-\frac{E_{vac} + E_s}{kT}\right)$$



Ring Mechanism

- Involves cooperative movement of two adjacent atoms
- Diffusion is easily achieved in alloys b/w two similar atoms
- This type of diffusion is highly unlikely in ionic crystals where cation and anion are adjacent to each other
- Interchange of positions by the neighbouring ions will make the structure energetically unstable

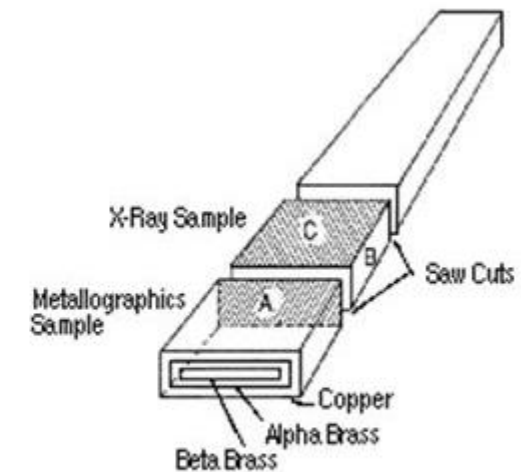
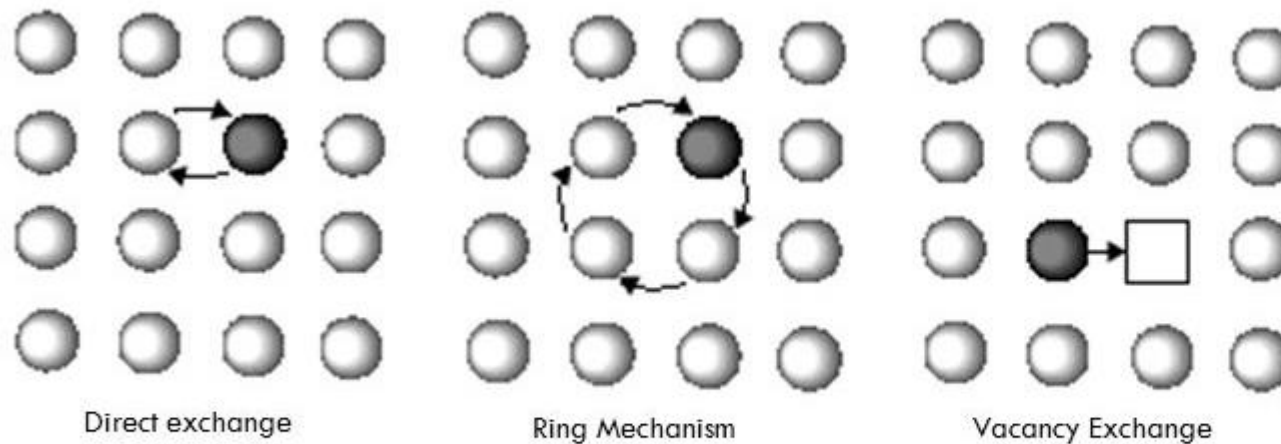

Solid State Reaction

- The solid-state reaction route is the most widely used method for the preparation of polycrystalline solids from a mixture of solid starting materials.
- Solids do not react together at room temperature over normal time scales and it is necessary to heat them to much higher temperatures, often to 1000 to 1500 °C in order for the reaction to occur at an appreciable rate.
- The factors on which the feasibility and rate of a solid state reaction depend include, reaction conditions, structural properties of the reactants, surface area of the solids, their reactivity and the thermodynamic free energy change associated with the reaction.
 - **Reagents**
 - **Mixing**
 - **Container material**
 - **Heat treatment**

➤ **Outline of the experimental procedure**

➤ **Reagents**

- These are the solid reactants from which it is proposed to prepare a solid crystalline compound.
- The selection of reactant chemicals depends on the reaction conditions and expected nature of the product.
- The reactants are dried thoroughly prior to weighing.
- As increase in surface area enhances the reaction rate, fine grained materials should be used if possible.

➤ **Outline of the experimental procedure**

➤ **Mixing**

- After the reactants have been weighed out in the required amounts, they are mixed.
- For manual mixing of small quantities, usually an agate mortar and pestle are employed.
- Sufficient amount of some volatile organic liquid – preferably acetone or alcohol – is added to the mixture to aid homogenization.
- This forms a paste which is mixed thoroughly.
- During the process of grinding and mixing, the organic liquid gradually volatilizes and has usually evaporated completely after 10 to 15 minutes.
- For quantities much larger than ~20g, mechanical mixing is usually adopted using a ball mill and the process may take several hours.

➤ **Outline of the experimental procedure**

➤ **Container material**

- For the subsequent reaction at high temperatures, it is necessary to choose a suitable container material which is chemically inert to the reactants under the heating conditions used.
- The noble metals, platinum and gold, are usually suitable.
- Containers may be crucibles or boats made from foil.
- For low temperature reactions, other metals like Nickel (below 600–700⁰C) can be used.

➤ **Outline of the experimental procedure**

➤ **Heat treatment**

- The heating programme to be used depends very much on the form and reactivity of the reactants.
- In the control of either temperature or atmosphere, nature of the reactant chemicals are considered in detail.
- A good furnace is used for heat treatment.
- Pelleting of samples is preferred prior to heating, since it increases the area of contact between the grains.

Factors affecting the rate of Solid State Reactions

Reaction condition

- Temperature is an important factor
- Rate of Reaction between MgO and Al₂O₃ to form the spinel MgAl₂O₄ is extremely slow at normal temp
- Reaction occurs at 1000⁰C
- For the completion of the reaction, the powdered mixture should be heated to 1500⁰C for several days

Factors affecting the rate of Solid State Reactions

Structural considerations

- Crystal structure of the solid product show similarities and differences with the solid reactants
- MgAl_2O_4 show similarities and differences with MgO and Al_2O_3
- MgO and spinel have cubic close packed array of oxide ions
- Al_2O_3 has a distorted hexagonal close packed array of oxide ions
- Al^{3+} ions occupy the octahedral sites in both spinel and Al_2O_3
- Mg^{2+} ions are in the octahedral in MgO while in tetrahedral in spinel

Factors affecting the rate of Solid State Reactions

Nucleation

- Initially reacting crystals are at intimate contact with each other
- After an appreciable heat treatment, the crystals have partially reacted to form a layer of MgAl_2O_4 nuclei
- This nucleation is difficult because of
 - a) structural difference between the reactants and products
 - b) structural reorganisation during the formation of product
 - c) bonds must be broken and reformed
 - d) for this ions should migrate over considerable distances
 - e) since ions are trapped on their appropriate lattice site, high thermal energy is required to jump out of this site and diffuse through the crystal

Factors affecting the rate of Solid State Reactions

Growth of the product layer

- Further reaction proceeds by the growth of the MgAl_2O_4 layer
- This is by counter diffusion of Mg^{2+} and Al^{3+} through the existing MgAl_2O_4 layer to new reaction interfaces
- At this stage there are two reaction interfaces, one b/w MgO and MgAl_2O_4 and the other b/w MgAl_2O_4 and Al_2O_3
- Further reaction rate depends on the rate of diffusion of Mg^{2+} and Al^{3+} to and from these interfaces
- Since the diffusion rates are low, even at low temp further reaction takes place slowly and rate decreases as the spinel layer grows thicker
- Rate controlling step of the reaction is the interdiffusion of cations through the spinel product layer

Factors affecting the rate of Solid State Reactions

Growth of the product layer

Wagner reaction mechanism

- Mechanism of reaction in the formation of the MgAl_2O_4 involves the counter diffusion of Mg^{2+} and Al^{3+} through Product layer followed by further reaction at two reaction – product interfaces is known as wagner reaction mechanism
- In order to maintain charge balance, every three Mg^{2+} ions diffuse to the right hand interface and two Al^{3+} ions must diffuse to the left hand interface

The reaction at the two interfaces are

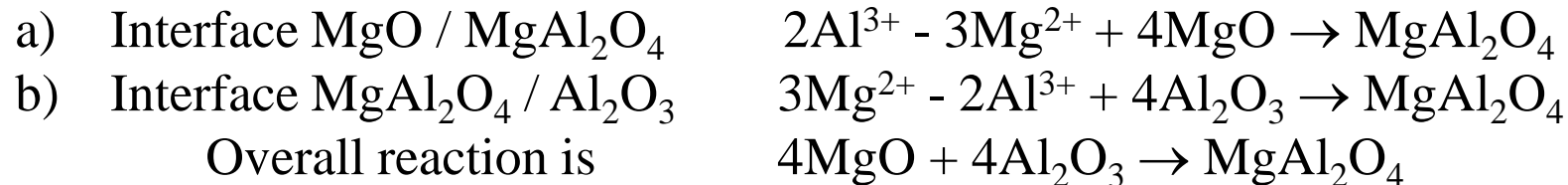

Factors affecting the rate of Solid State Reactions

Growth of the product layer - Wagner reaction mechanism

The reaction at the two interfaces are

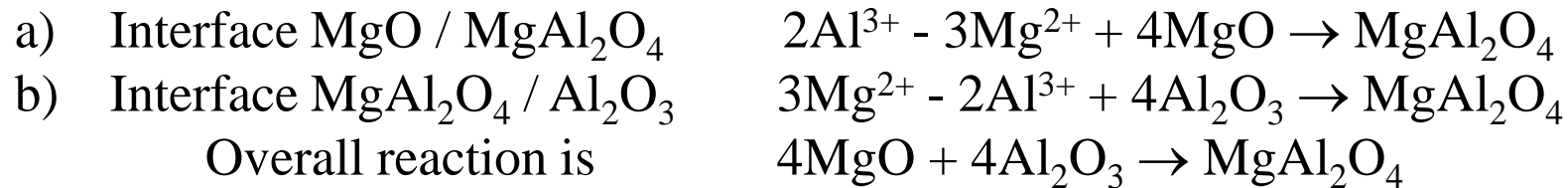

- Reaction (b) gives three times as much spinel product than reaction (a)
- Right hand side interface moves at a rate three times faster than the left hand interface
- This mechanism has been proved experimentally for a similar reaction that b/w MgO and Fe₂O₃ to form Spinel MgFe₂O₄.
- It was found that two interfaces moved in the ration 1 : 2.7 .
- In such reactions, the interface b/w the reactant and product can be clearly seen due to difference in color
- Movement of the interface may be used as a marker to monitor the progress of the reaction.
- This effect of using a marker is known as Kirkendall effect

The Kirkendall effect

- The Kirkendall effect is the motion of the interface between two metals that occurs as a consequence of the difference in diffusion rates of the metal atoms.
- The effect can be observed for example by placing insoluble markers at the interface between a pure metal and an alloy containing that metal, and heating to a temperature where atomic diffusion is possible; the boundary will move relative to the markers.
- The Kirkendall effect has important practical consequences.
- One of these is the prevention or suppression of voids formed at the boundary interface in various kinds of alloy to metal bonding. These are referred to as Kirkendall voids.

KIRKENDALL EFFECT

OTHER SOLID STATE REACTIONS

- $\text{MgO} + \text{Fe}_2\text{O}_3 \rightarrow \text{MgFe}_2\text{O}_4$
- Different color interfaces
- Easily monitored rates
- Other examples - calculate the Kirkendall ratio:
- $\text{SrO} + \text{TiO}_2 \rightarrow \text{SrTiO}_3$ Perovskite, AMO_3 (type ReO_3)
- $2\text{KF} + \text{NiF}_2 \rightarrow \text{K}_2\text{NiF}_4$ Corner Sharing Oh $\text{NiF}_6(2-)$ Sheets, Inter-sheet $\text{K}(+)$
- $2\text{SiO}_2 + \text{Li}_2\text{O} \rightarrow \text{Li}_2\text{Si}_2\text{O}_5$

➤ **The important factors that influence the rate of solid state reactions are**

- Area of contact between the reacting solids and hence the surface area
- The rate of nucleation of the product phase
- Rate of diffusion of the various ions through the product phase

➤ **Surface area of solids**

- TSA of any solid increases with decreasing particle size
- Surface area influences the reaction rate
- Total area of contact b/w the grains of the reacting solids depends on the total surface area of grains
- Contact area is considerably less than total surface area
- Contact area may be increased by pressing the reacting powder into pellets
- But pellets are porous and crystal contacts are not maximized
- Compressing the pellets increases the contact area and reduction in pellets porosity

➤ **Reactivity of solids – Nucleation and diffusion rates**

- Two stages in the reaction of two solids – Nucleation of the product and its subsequent growth
- Nucleation is facilitated if there is a structural similarity b/w the product and one or both of the reactants
- In the reaction b/w MgO and Al₂O₃ to form spinel, spinel has a similar oxide arrangement to that in MgO
- Spinel nuclei form at the surface of MgO
- Oxide arrangement is essentially continuous across the MgO-spinel interface

NUCLEATION OF PRODUCT PHASE

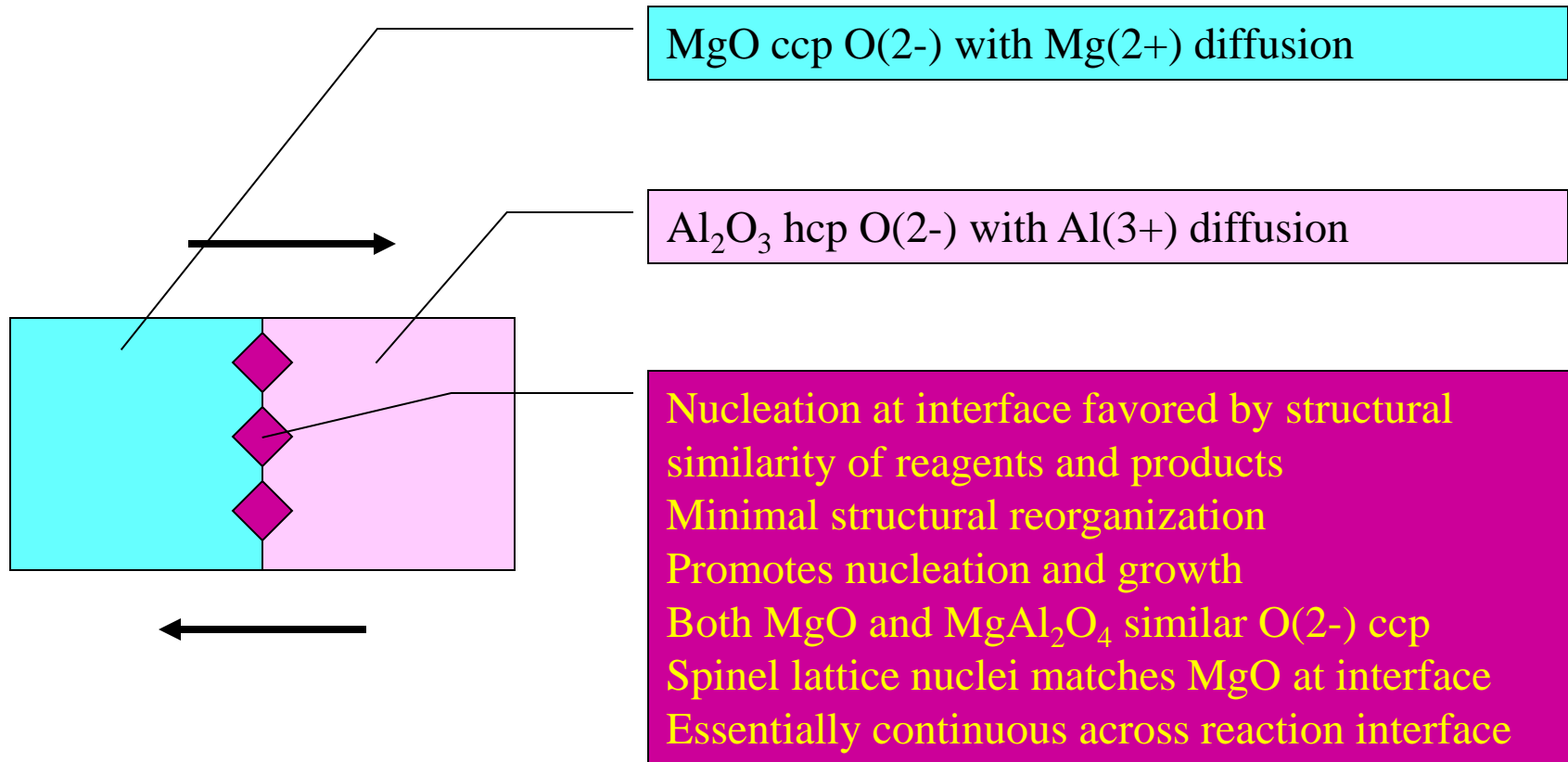

**STRUCTURAL SIMILARITY OF REACTANTS AND PRODUCTS
PROMOTES NUCLEATION RATE AND PRODUCT GROWTH**

➤ **Surface structure and reactivity**

- Ease of nucleation of product phases also depends on actual surface structure of the reacting phases
- Structure cannot be the same over the entire crystal surface
- Different surfaces have different structures, reactivity is different
- Reactivity of solids depends greatly on the presence of crystal defect
- Process of nucleation is much easier in the defect area
- Defect region provides convenient sites for atoms, ions or molecules to attach themselves and hence the crystal to grow larger

➤ **Topotactic and Epitactic reactions**

- If nucleation make use of a structural similarity between the product nucleus and existing phases, there is a clear orientational relationship between the reactant and product
- Two types of oriented reactions are identified : **Epitactic and Topotactic reactions**
- In Epitactic reactions, the structural relationship between the two phases is restricted to actual interface between two crystals
- Two structures have a common arrangement of oxide ions at the interface but oxide arrangement to either side is different
- Epitactic reactions therefore require only a two dimensional structural similarity at the crystal interface
- Topotactic reactions not only the structural similarity at the interface but this similarity should continue into the bulk of both crystalline phases
- This could occur for the topotactic growth of the spinel on MgO if the cubic close packed oxide ion arrangement continued across the interface

TOPOTACTIC AND EPITACTIC REACTIONS

- **What about orientation effects on reactivity in the bulk and surface regions of solids?**
- **Implies structural relationships between two phases**
- **Topotactic reactions occur in bulk materials with 1D, 2D or 3-D structures - 1D TiS_3 , 2D MoO_3 , 3D WO_3**
- **Topotaxy more specific, require interfacial and bulk crystalline structural similarity, lattice matching**

➤ **Synthesis of solids**

➤ Synthesis of $\text{YBa}_2\text{Cu}_3\text{O}_7$ (YBCO)

- $\text{YBa}_2\text{Cu}_3\text{O}_7$ (YBCO) is a classic 90K superconductor

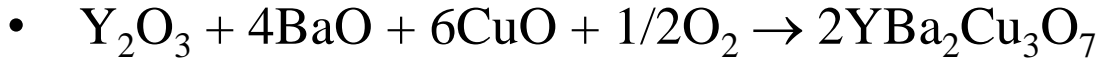

- BaNO_3 on heating gives BaO

➤ Synthesis of $\text{Na } \beta / \beta^{11}$ alumina

- $\text{Na } \beta / \beta^{11}$ alumina is a classic Na^+ ion conducting electrolyte

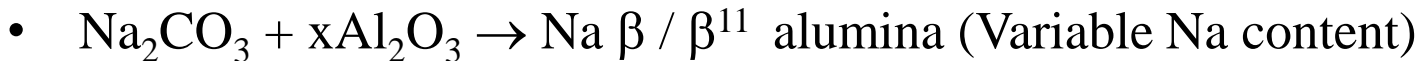

- Na_2O is volatile at the required temperature, low temp cannot be used because of inertness of Al_2O_3

➤ **Synthesis of solids**

➤ **Sol-gel Method**

- Homogeneous solution containing all the cationic ingredients is prepared
- The solution is gradually dried
- It may transform to a viscous sol containing particles of colloidal dimensions
- Finally to a transparent homogenous amorphous solid known as gel without precipitation of any crystalline phase
- It is then fired at high temperatures to remove volatile components
- The reagent for sol-gel synthesis is usually metal organic compounds especially alkoxides

TEOS + H₂O + solvent
(catalyst)

• Hydrolysis and condensation

Colloidal silica

• Ageing

Silica gel

• Drying and calcination

Bulk or silica powder

➤ **Synthesis of solids**

➤ Synthesis of Indium Tin oxide (ITO)

- Widely used as an electrode
- Used as a coating on glass for energy control of buildings since it transmits visible light and reflects infrared radiations
- The coating is prepared by sol gel method
- A thin film of In and Sn alkoxides is poured on the substrate or alternately the substrate is dipped in the liquid precursor mixture.
- The coating is then dried
- A large reduction in volume occurs on drying

➤ **Synthesis of solids**

➤ Synthesis of Zeolites

- Aluminosilicate materials containing large interconnected voids and channels
- Permit either ready ion exchange processes or to enter small organic molecules where they can undergo various transformations or reactions.
- These microporous solids are prepared by sol gel method
- $$\text{Na}(\text{Al}(\text{OH})_4) \text{ aq} + \text{Na}_2\text{SiO}_3 \text{ aq} + \text{NaOH} \xrightarrow{25^\circ\text{C}} \text{gel} \xrightarrow{25 - 175^\circ\text{C hydrothermal (heat in high pressure of water)}} \text{Na}_w\text{Al}_x\text{Si}_y\text{O}_z$$
- Particular zeolite formed depends not only on the starting composition, temperature and pressure but also on the particular template that is added
- Template is usually alkyl ammonium cation around which aluminosilicate structure crystallises
- After crystallization, it is heated to 300 - 400°C to burn off the organic material leaving intact the inorganic frame work

➤ Intercalation and deintercalation

- Most intercalation and deintercalation reactions involve the addition or removal of ions commonly Li^+ , Na^+ , H^+ , O^{2-}
- To preserve charge balance, electrons must be added or removed
- These are solid state redox processes
- The requirement is that the host metal should be mixed conductors so as to allow the migration of both ions and electrons

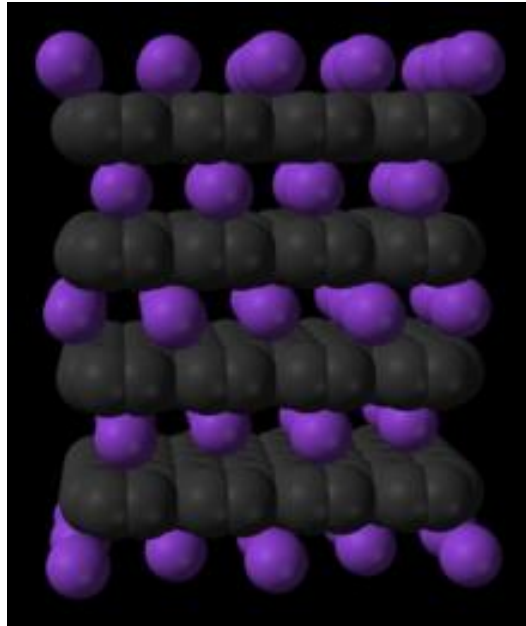

➤ Intercalation and deintercalation

- Intercalation of alkali metals or H^+ ions into WO_3 to form tungsten bronze
- Intercalation and deintercalation of Li into $LiMn_2O_4$ or Li_xCoO_2 cathode material in solid state lithium batteries
- Topotactic conversion of anatase polymorph TiO_2 which is white and insulating solid to Lithium titanate which is a super conductor (Insulator to super conductor transformation)
 - First step: To react anatase (TiO_2) with n-butyl lithium dissolved in hexane.
 - Li^+ ion and electrons intercalate to the anatase structure.
 - No Structural changes occur on intercalation.
 - Second step: Heat Lithiated anatase to $500^\circ C$
 - Structural reorganization occur and gives material with same composition but with spinel structure which is super conducting

intercalation

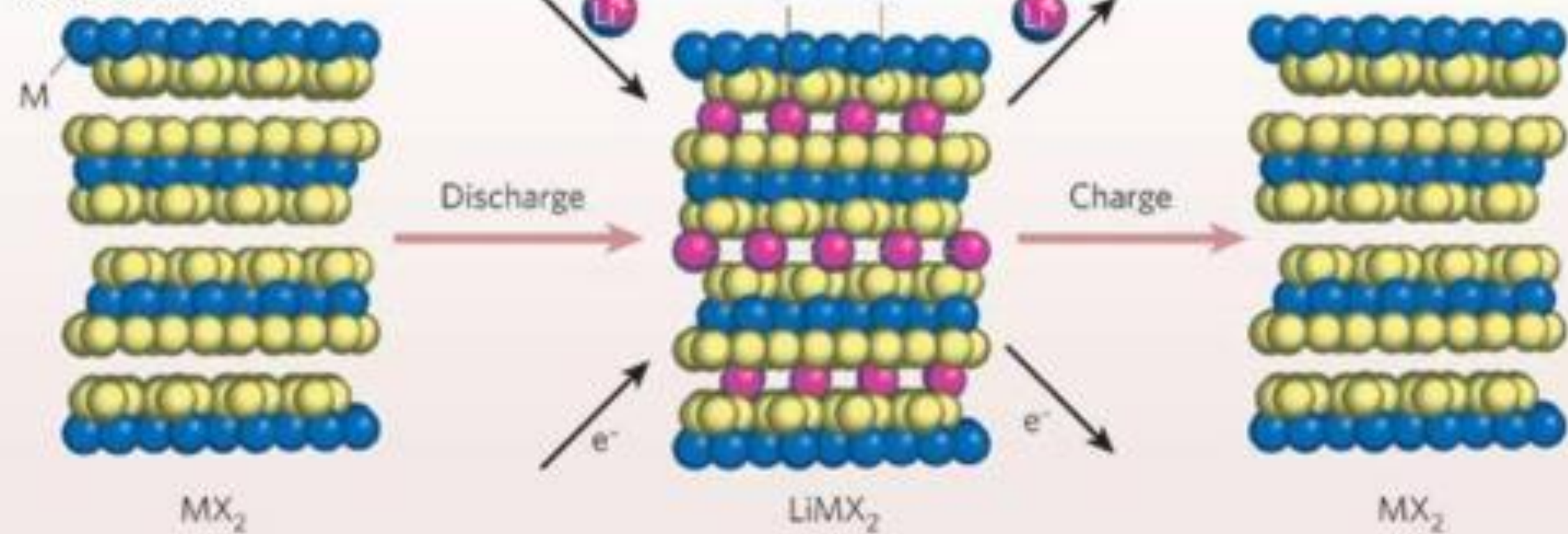

➤ Intercalation and deintercalation compounds of graphite

- Graphite is a classic example for a host crystal that is capable of intercalating a wide variety of atoms, molecules and ions
- Graphite has a planar ring structure, intercalate alkali cations, halide ions, ammonia and amines etc between the carbon layers
- Most of the reactions are reversible because the structure and planarity of the carbon layers are unaffected by intercalation
- C₈K formed on exposure of graphite to molten K and K may be subsequently removed under vacuum
- Bonding within the graphite layer is strong
- Adjacent layers are held together by vanderWaals force with interlayer spacing 3.5Å
- This weak bonding permits suitable foreign materials to intercalate between the layers and push them apart 5.5Å in Graphite fluorine compounds

GRAPHITE INTERCALATION COMPOUNDS

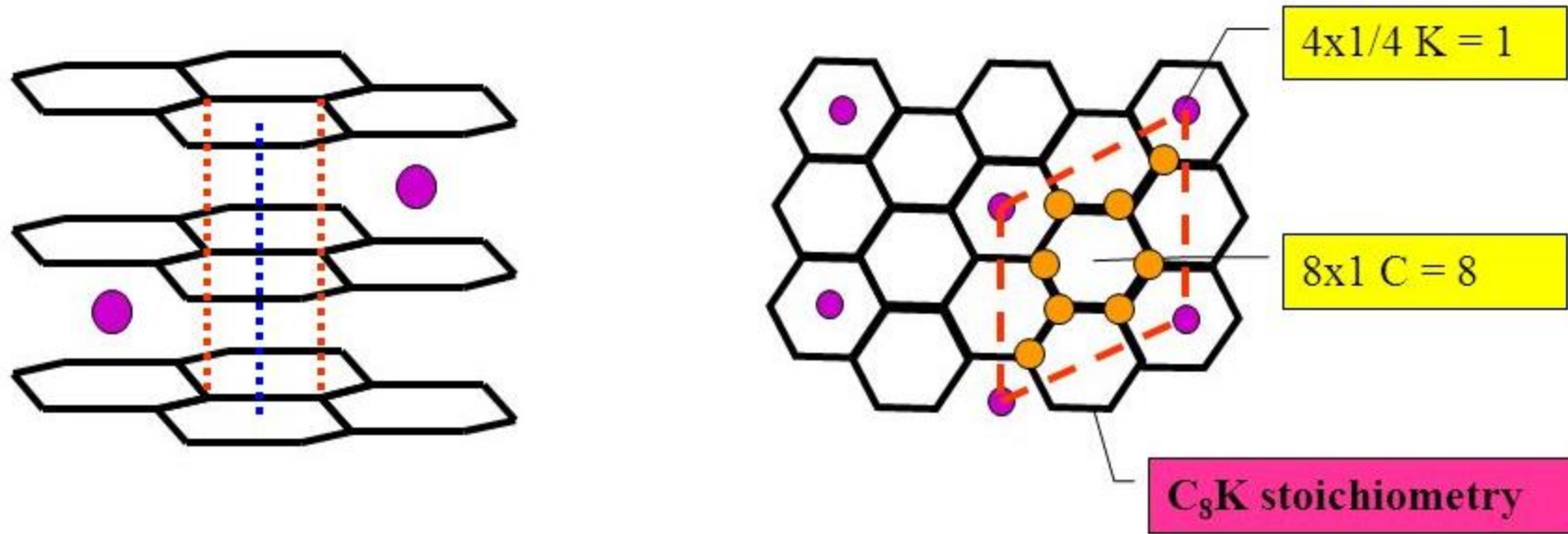

G (s) + K (melt or vapor) → C₈K (bronze)

C₈K (vacuum, heat) → C₂₄K → C₃₆K → C₄₈K → C₆₀K

Staging, distinct phases, ordered guests, K → G CT

AAAA sheet stacking sequence

K nesting between parallel eclipsed hexagons,

Typical of many graphite H-G inclusion compounds

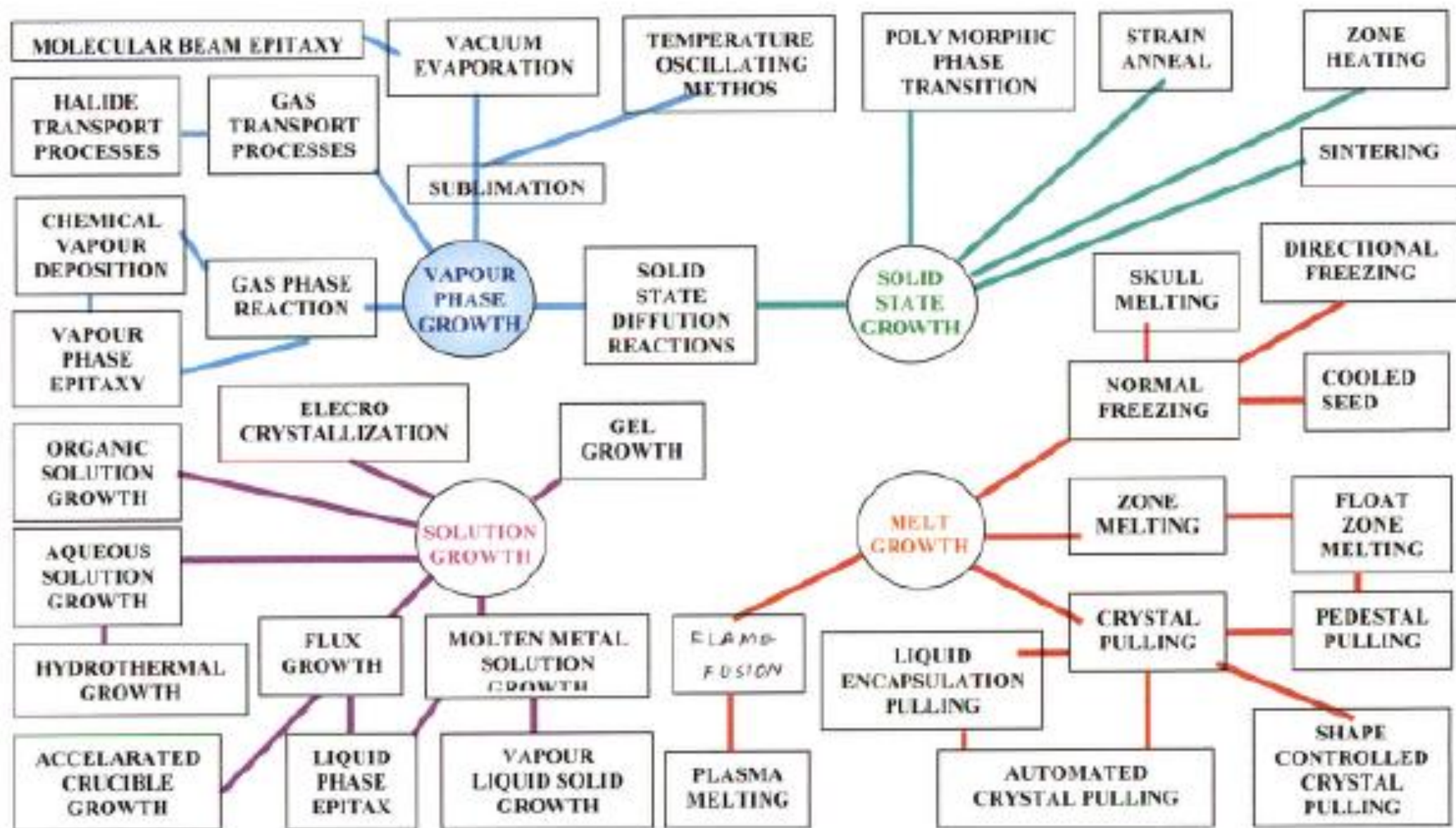

Fig. 3.1 The different crystal growth techniques.

➤ **Chemical vapour deposition method**

- Technique to deposit films of many inorganic materials on suitable substrate
- Volatile inorganic compound is decomposed above the substrate
- When the compound is metallo-organic complex, it is called metallo organic chemical vapour deposition (MOCVD)
- Simple metal alkyl provide a route to deposit the metal or its compounds through reaction with suitable gas molecules

Phase Transition in Solids

Introduction

- A **phase transition** is the transformation of a thermodynamic system from one phase or state of matter to another one by heat transfer.
- During a phase transition of a given medium certain properties of the medium change, often discontinuously, as a result of the change of some external condition, such as temperature, pressure, or others
- For example, a liquid may become gas upon heating to the boiling point, resulting in an abrupt change in volume.

Phase Transition in Solids

- Phase transition is important in solid science
- Important technologically, for eg. In the synthesis of diamond from graphite,
- Process for strengthening of steel
- Properties of Ferro electricity and ferromagnetism

Phase Transition in Solids

- If a crystalline material is capable of existing in two or more polymorphic forms (e.g diamond and graphite), the process of transformation from one polymorph to another is called phase transition
- Phase transitions are restricted to changes in structure only, without any changes in composition
- More than one phase may be present before or after the transition

Phase Transition in Solids

- Phase transitions are affected by both thermodynamic and kinetic factors
- Thermodynamics gives the behavior that should be observed under equilibrium conditions
- Phase transitions occur as a response to change in conditions usually temperature or pressure but sometimes composition
- The rate at which transition occurs ie kinetics are governed by various factors
- Transition that proceed by nucleation and growth mechanism are often slow because the rate controlling step ie nucleation is difficult
- In martensitic and displacive phase transitions, nucleation is easy, occurs spontaneously and rate of transition are usually fast

Phase Transition in Solids

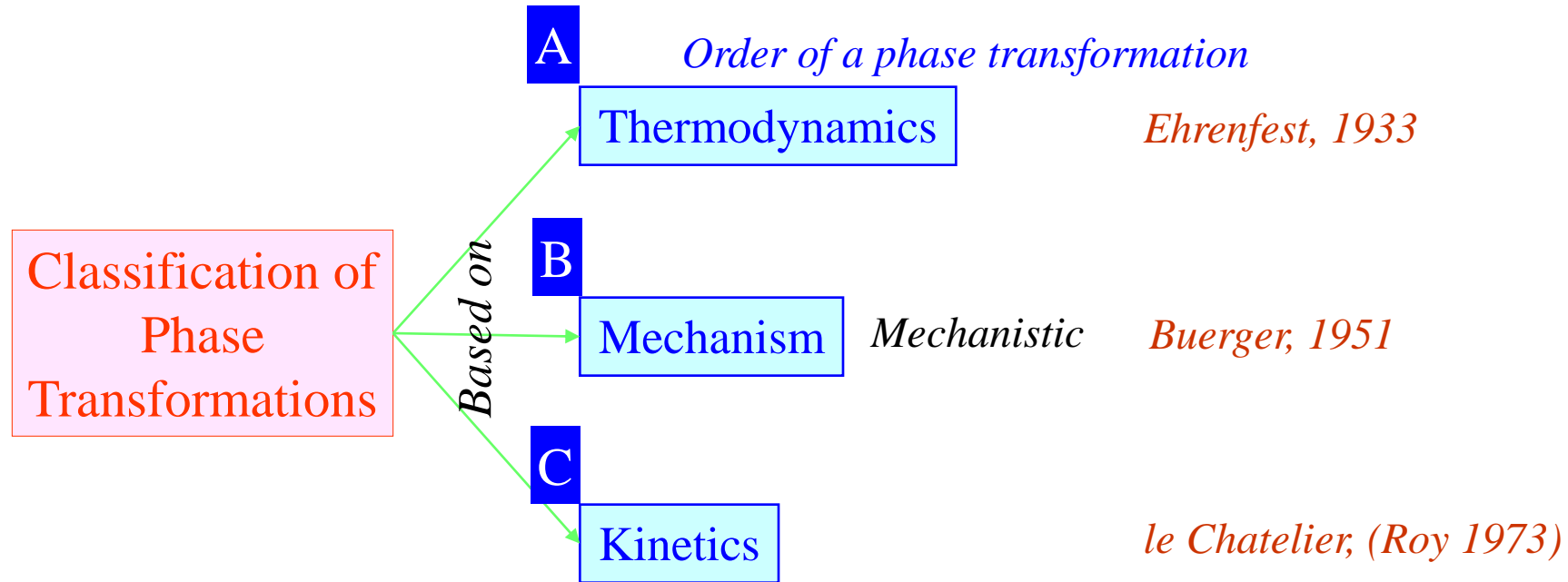

Phase Transition in Solids

Ehrenfest's Classification

- ✓ **First order phase transition:** Discontinuity in the first derivative of Gibb's Free Energy, G.
- ✓ **Second order phase transition:** Continuous first derivative but discontinuity in the second derivative of G.

Higher-order phase transitions

	Differential of G		Discontinuity appears in: Corresponding experim. quantities		
	<i>S</i>	<i>V</i>	<i>S</i>	<i>V</i>	
First					
Second	$\left(\frac{\partial S}{\partial T}\right)_p$	$\left(\frac{\partial V}{\partial T}\right)_p$	C_p	β	κ
	$\left(\frac{\partial S}{\partial p}\right)_T$	$\left(\frac{\partial V}{\partial p}\right)_T$			
Third	$\left(\frac{\partial^2 S}{\partial T^2}\right)_p$	$\left(\frac{\partial^2 V}{\partial T^2}\right)_p$	$\left(\frac{\partial C_p}{\partial T}\right)_p$	$\left(\frac{\partial \beta}{\partial T}\right)_p$	$\left(\frac{\partial \kappa}{\partial T}\right)_p$
	$\frac{\partial^2 S}{\partial p \partial T}$	$\frac{\partial^2 V}{\partial p \partial T}$	$\left(\frac{\partial C_p}{\partial p}\right)_T$	$\left(\frac{\partial \beta}{\partial p}\right)_T$	$\left(\frac{\partial \kappa}{\partial p}\right)_T$
	$\left(\frac{\partial^2 S}{\partial p^2}\right)_T$	$\left(\frac{\partial^2 V}{\partial p^2}\right)_T$			

First order

E.g.: Melting

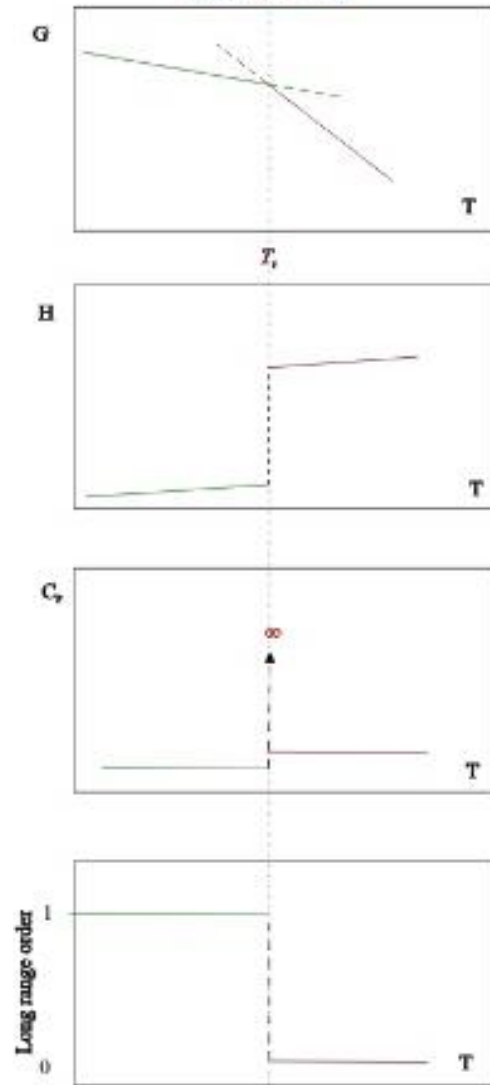

Second order

E.g.: Disordering of β -brass

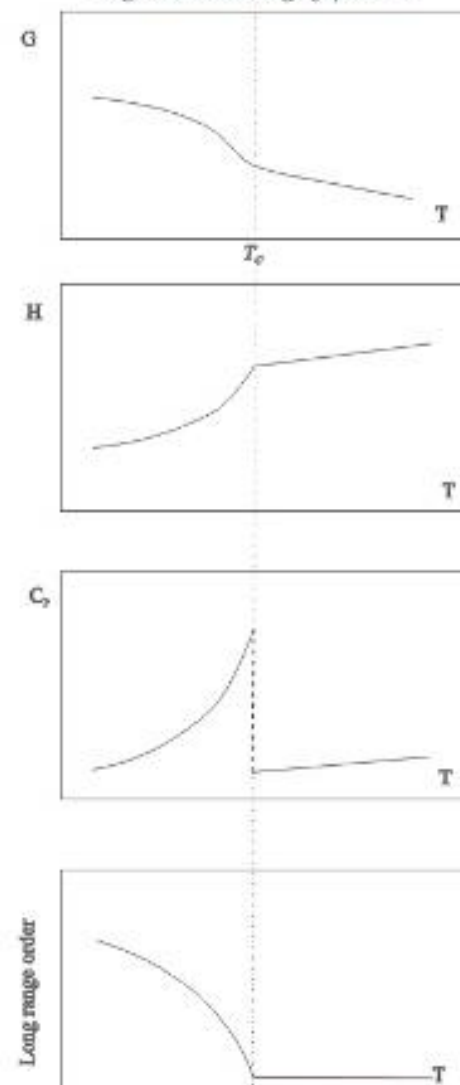

Buerger's Classification

✓ **Reconstructive Transition:** Involves a major reorganization of the crystal structure. *Diffusional or Civilian*

E.g: Graphite \longleftrightarrow Diamond

✓ **Displacive Transition:** *Military*

Involves distortion of bond rather than their breaking and the structural changes.

E.g: Martensitic Transformation

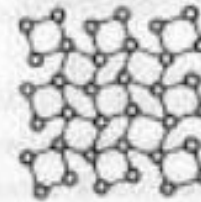
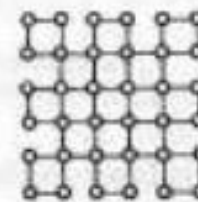
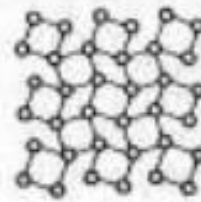
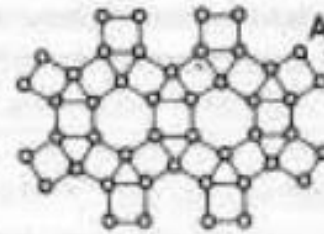

Fig. 12.1 Transformation from structure A to any other structure requires the breaking of first coordination bonds. Transformations among B, C and D are distortional only. (After Buerger, 1961)

Reconstructive Phase Transitions

- Reconstructive transitions involve a major reorganization of the crystal structure
- Bonds have to be broken and new bonds formed
- The transition graphite to diamond is reconstructive and involves complete change in crystal structure
- From hexagonal sheets of three coordinated carbon atoms in graphite to infinite frame work of four coordinated Carbon atoms in diamond
- Another example is quartz cristoblite transition in SiO_4 tetrahedral
- Because many bonds must break, reconstructive transitions usually have high activation energy and therefore takes place only slowly
- Reconstructive transitions may be prevented from occurring
- Since there is no structural relationship between the two polymorphs, there is no relation between the symmetry and space group between the two polymorphs

Displacive Phase Transitions

- Involves distortion of bonds
- Displacive transitions usually have zero or low activation energy and therefore cannot be prevented from occurring
- Structural similarity, symmetry relationships exists between the two polymorphs
- Symmetry of low temperature polymorph is lower than and belongs to a sub group of that of the high temperature polymorph
- Three main polymorphs of silica: quartz, tridymite and cristobalite all of which undergo displacive low-high transitions
- These transitions involve small distortions or rotations of SiO_4 tetrahedral, without breaking any primary Si-O bonds

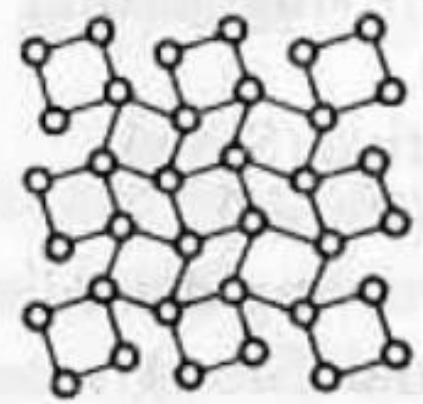
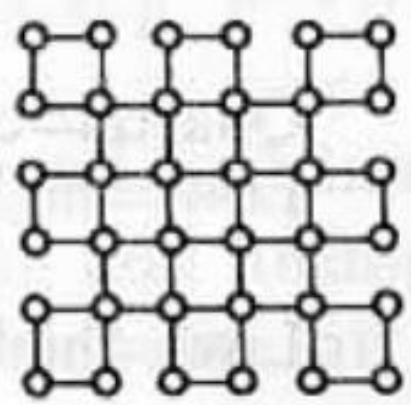
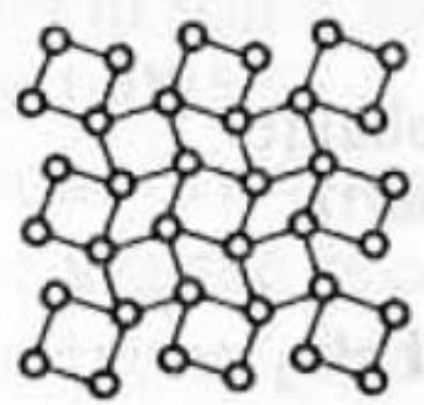
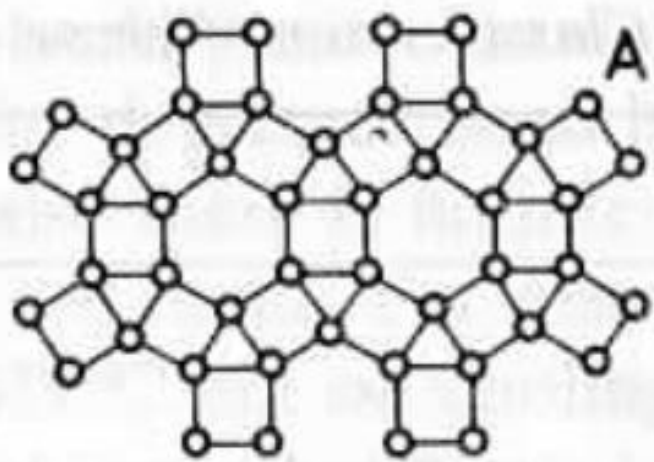

B

C

D

Buerger's Classification: full list

❑ Transformation involving first coordination

- Reconstructive (sluggish) Diamond ⇌ Graphite
- Dilatational (rapid) Rock salt ⇌ CsCl

❑ Transformation involving second coordination

- Reconstructive (sluggish) Quartz ⇌ Cristobalite
- Displacive (rapid) Low ⇌ High Quartz

❑ Transformations involving disorder

- Substitutional (sluggish) Low ⇌ High LiFeO₂
- Rotational (rapid) Ferroelectric ⇌ Paraelectric NH₄H₂PO₄

❑ Transformations involving bond type (sluggish)

Grey ⇌ White Sn

Martensitic Phase Transitions

- Special kind of transformation which occur in a variety of metallic and non-metallic systems
- Martensite was the name originally given to the hard material obtained during the quenching of steels
- Formed by the transformation of Austenite, the face centered cubic solid solution of carbon in γ -Fe
- Austenite is unstable below 723°C , decompose under equilibrium conditions to a mixture of α -Fe and cementite, Fe_3C
- On quenching Austenite, this eutectoid decomposition reaction is suppressed and instead the undercooled cubic austenite transforms to a metastable tetragonal phase martensite

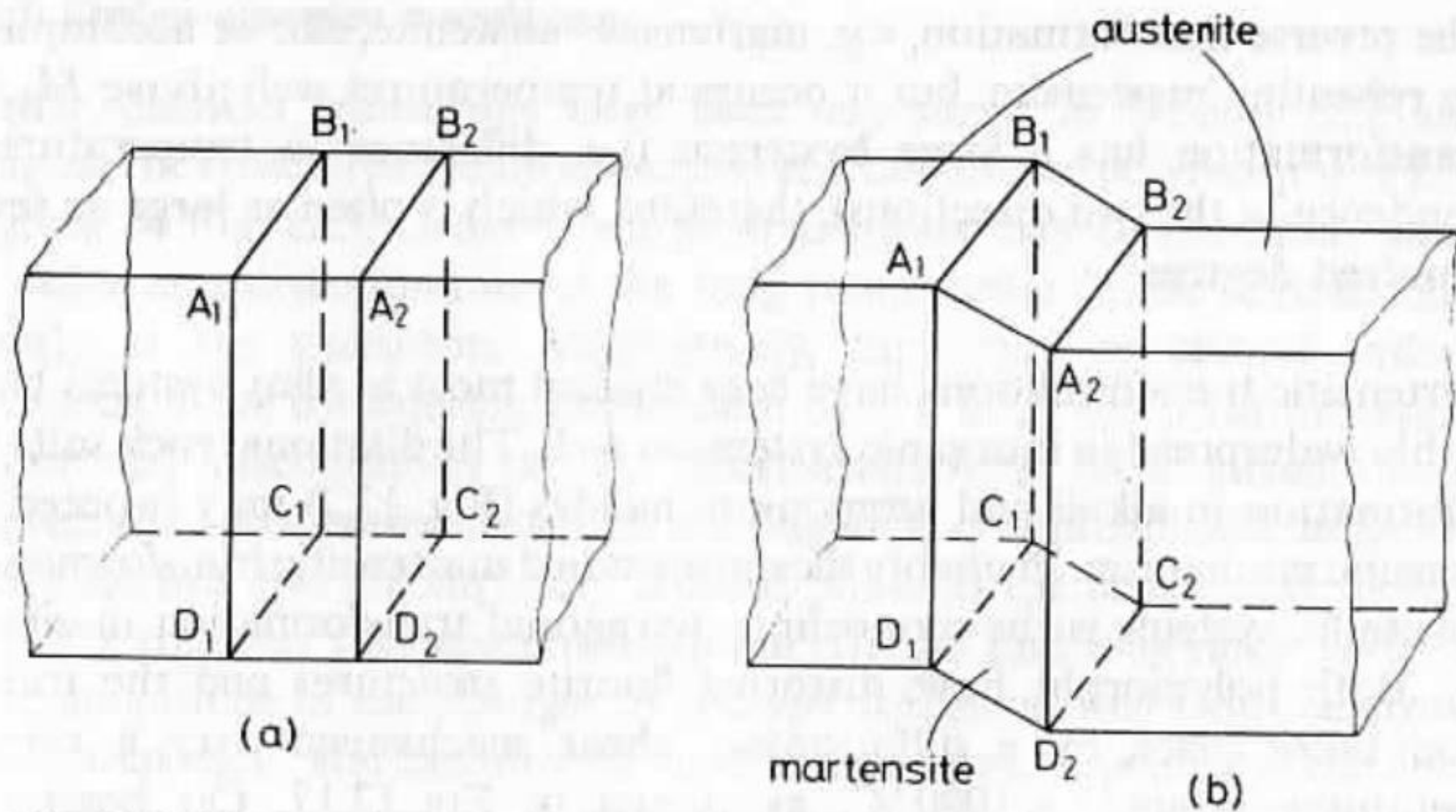

Fig. 12.16 Formation of a martensite plate within a parent austenite crystal

Order-Disorder Transitions

- Atoms of two elements in a binary solid solvent may be randomly dispersed over the available lattice positions or show a regular arrangement with respect to each other
- The latter arrangement is known as super lattice
- The crystallographic transformation by which a super lattice is formed from a random solution is known as order-disorder transition
- When a random solid solution formed at an elevated temperature is slowly cooled, there may exist a tendency for the atoms to order
- If the ordering forces are weak, each atom is surrounded itself with unlike atoms for short periods of time
- On an average, it is surrounded by more unlike atoms than would be in a completely random arrangement. This is called short range order
- If the ordering forces are large, the atoms arrange themselves in specific lattice array leading to a long range order

Order-Disorder Transitions

Order–disorder transitions that involve atoms or ions exchanging places (i.e. substitutional effects) are usually sluggish. The structures of ordered and disordered polymorphs of LiFeO_2 , stable below and above $\sim 700^\circ\text{C}$, respectively, are shown in Fig. 12.3. The disordered polymorph may be readily preserved to room temperature where it is kinetically stable. It has a rock salt structure with Li^+ and Fe^{3+} ions distributed at random over the octahedral sites of the face centred cubic unit cell (Fig. 12.3b). On heating disordered LiFeO_2 at, for example, 600°C , the oxide ion arrangement remains unchanged but the cations order themselves over the octahedral sites (Fig. 12.3a), resulting in a larger unit cell of lower symmetry (tetragonal). The ordering reaction involves cation migration and takes place only slowly. As in all reconstructive tran-

Order-Disorder Transitions

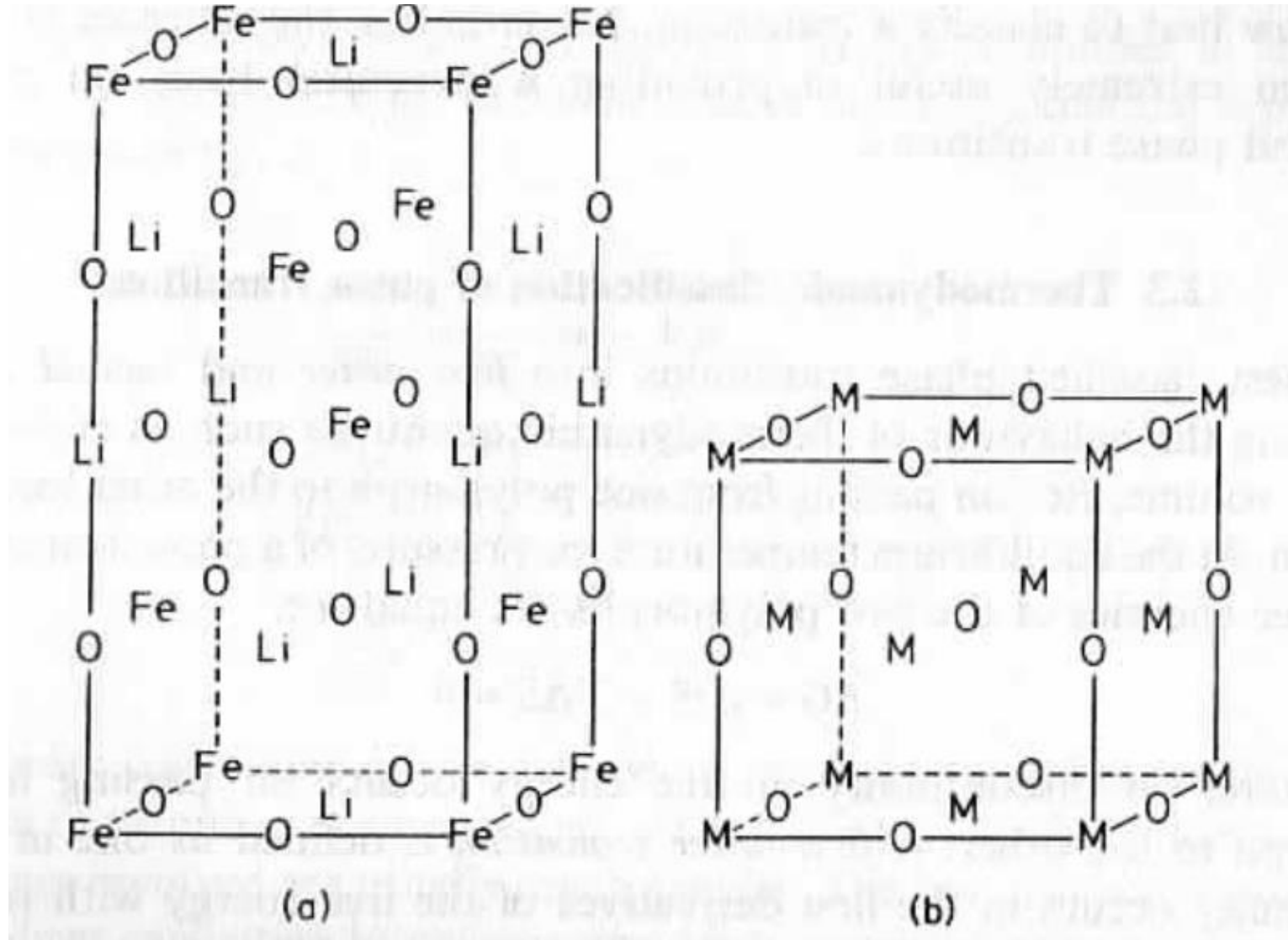

Kinetics of Phase Transition:

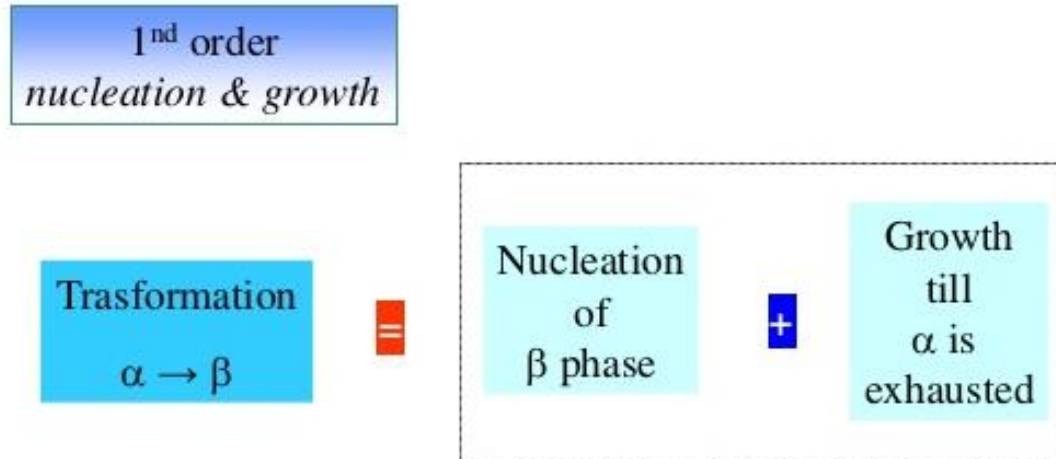

Phase Transformations

Nucleation

- nuclei (seeds) act as templates on which crystals grow
- for nucleus to form rate of addition of atoms to nucleus must be faster than rate of loss
- once nucleated, growth proceeds until equilibrium is attained

Driving force to nucleate increases as we increase ΔT

- **supercooling** (eutectic, eutectoid)
- **superheating** (peritectic)

Small supercooling \rightarrow slow nucleation rate - few nuclei - large crystals

Large supercooling \rightarrow rapid nucleation rate - many nuclei - small crystals

Heterogeneous nucleation

- Nucleation occur at the interface between two phases or at the grain boundary.

Homogeneous nucleation

- Nucleation occur without any preferential nucleation sites.
- Occurs spontaneously and randomly but it requires superheating or supercooling.

An example of supercooling: Pure water freezes at -42°C rather than at its freezing temperature of 0°C . The crystallization into ice may be facilitated by adding some nucleation "seeds": small ice particles, or simply by shaking

1) Martensitic Transformation:

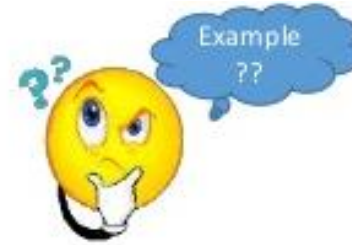

- ❑ The martensitic transformation occurs without composition change
- ❑ The transformation occurs by shear without need for diffusion
- ❑ The atomic movements required are only a fraction of the interatomic spacing
- ❑ The shear changes the shape of the transforming region
 - results in considerable amount of shear energy
 - plate-like shape of Martensite
- ❑ The amount of martensite formed is a function of the temperature to which the sample is quenched and not of time
- ❑ Hardness of martensite is a function of the carbon content
 - but high hardness steel is very brittle as martensite is brittle

Crystal Growth

INTRODUCTION

- **CRYSTAL:** A crystal is a three dimensional arrangement of atoms and crystalline solid refers to aggregates of atoms/molecules/their ions arranged in a regular repetition.
- **Crystallization** is a process of formation of crystals from the solvent in which the solute is dissolved.
- Crystallization is employed as the final step in the purification of a solid.

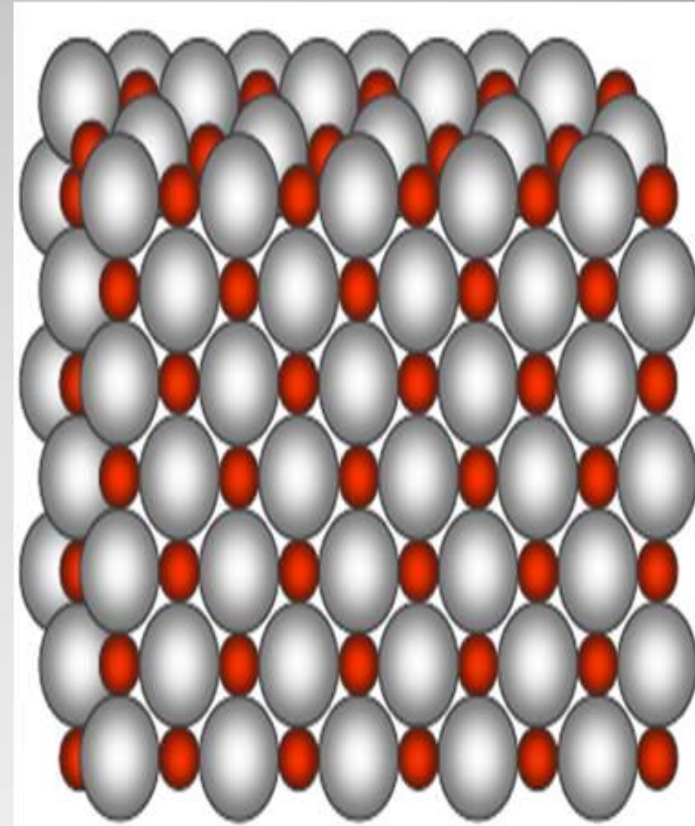

Crystal Growth

- **How do single crystals differ from polycrystalline samples?**

Single crystal specimens maintain translational symmetry over macroscopic distances (crystal dimensions are typically 0.1 mm – 10 cm).

- **Why would one go to the effort of growing a single crystal?**

-Structure determination and intrinsic property measurements are preferably, sometimes exclusively, carried out on single crystals.

-For certain applications, most notably those which rely on optical and/or electronic properties (laser crystals, semiconductors, etc.), single crystals are necessary.

Crystal Growth

- Crystal growth is the process where a pre-existing crystal becomes larger as more molecules or ions add in their positions in the crystal lattice
- A crystal is defined as being atoms, molecules, or ions arranged in an orderly repeating pattern, a crystal lattice, extending in all three spatial dimensions.
- Crystal growth differs from growth of a liquid droplet in that during growth the molecules or ions must fall into the correct lattice positions in order for a well-ordered crystal to grow.
- When the molecules or ions fall into the positions different from those in a perfect crystal lattice, crystal defects are formed.
- Typically, the molecules or ions in a crystal lattice are trapped in the sense that they cannot move from their positions, and so crystal growth is often irreversible, as once the molecules or ions have fallen into place in the growing lattice, they are fixed in place.

Crystal Growth

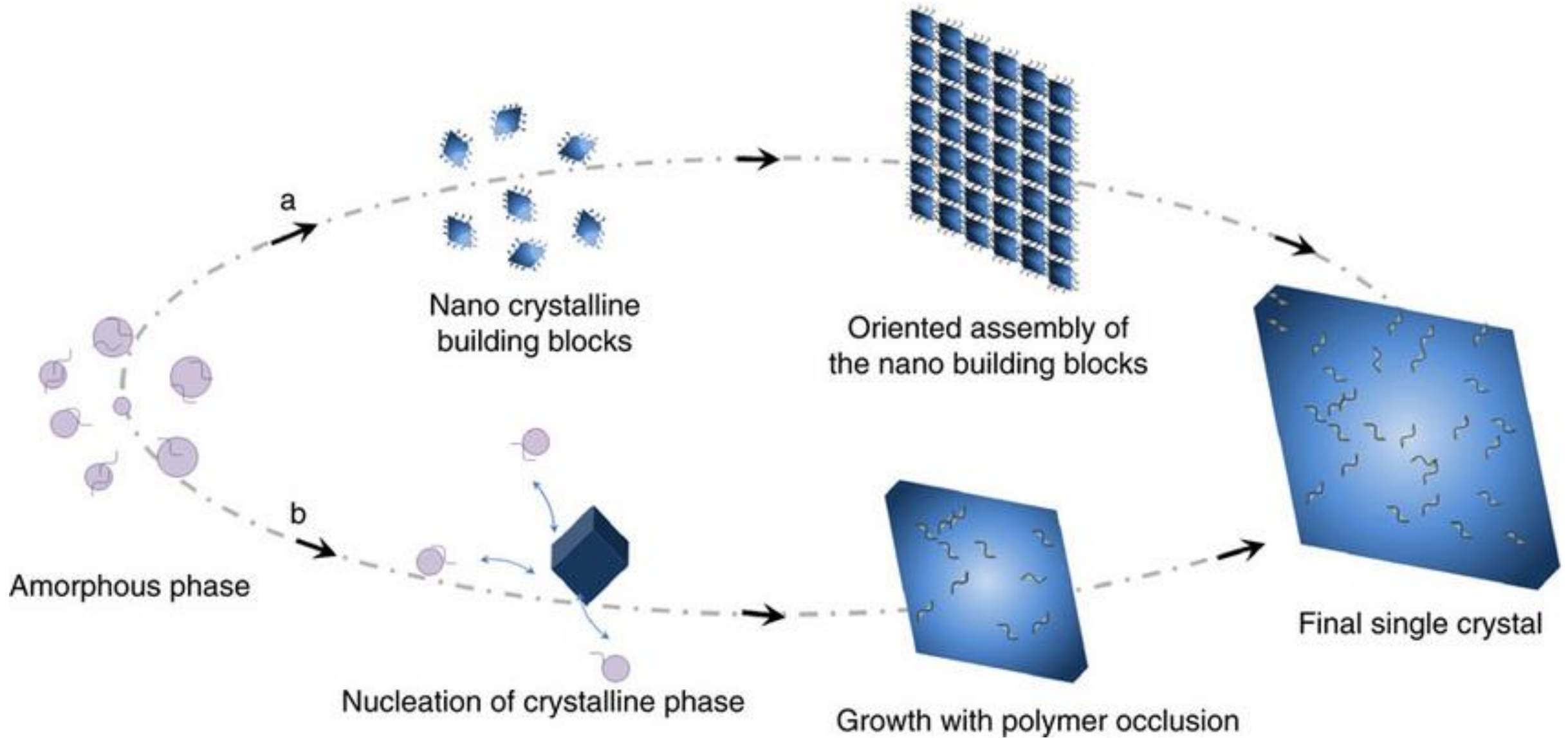

Crystal Growth

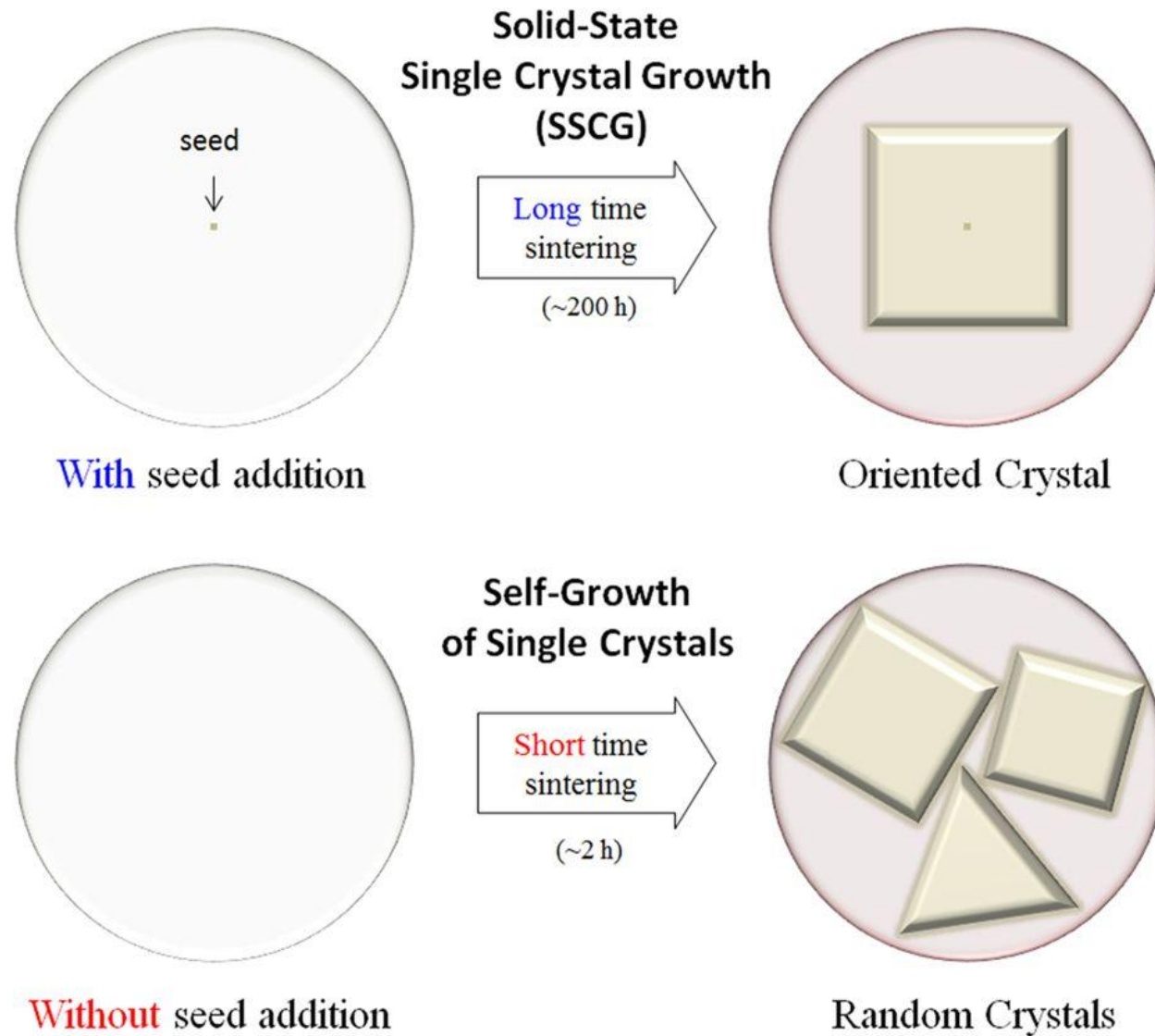

Crystal Growth

- Crystal growth from Melt
- Crystal growth from Solution
- Crystal growth from Vapour

Crystal Growth

Table 2.1. Classification of various crystal growth techniques

Sl. No	Types	Classification	Techniques
1.	Melt growth	liquid to solid phase transition	Bridgman- stockborges method Czochralski Method Verneuil Method Zone Melting Method Strain – Annealing Method
2.	Vapour growth	Gas to solid phase transition	Chemical transport method Physical transport method.
3.	Solution growth	Solution-to-Solution phase transition	Low temperature solution growth High temperature solution growth Hydrothermal growth Gel growth

Crystal Growth from melt - Czochralski process

- Czochralski process is a method of crystal growth used to obtain single crystals of semiconductors (e.g. silicon, germanium and gallium arsenide), metals (e.g. palladium, platinum, silver, gold), salts and synthetic gemstones.
- The process is named after Polish scientist Jan Czochralski, who invented the method in 1915 while investigating the crystallization rates of metals.
- He made this discovery by accident, while studying the crystallization rate of metals when, instead of dipping his pen into the ink, he did so in molten tin and drew a tin filament, that later proved to be a single crystal.
- The most important application may be the growth of large cylindrical ingots, or boules, of single crystal silicon used in the electronics industry to make semiconductor devices like integrated circuits.
- Other semiconductors, such as gallium arsenide, can also be grown by this method

Crystal Growth from melt - Czochralski process

- Monocrystalline silicon (mono-Si) grown by the Czochralski process is often referred to as monocrystalline Czochralski silicon (Cz-Si).
- It is the basic material in the production of integrated circuits used in computers, TVs, mobile phones and all types of electronic equipment and semiconductor devices.
- Monocrystalline silicon is also used in large quantities by the photovoltaic industry for the production of conventional mono-Si solar cells.
- The almost perfect crystal structure yields the highest light-to-electricity conversion efficiency for silicon

Crystal Growth from melt - Czochralski process

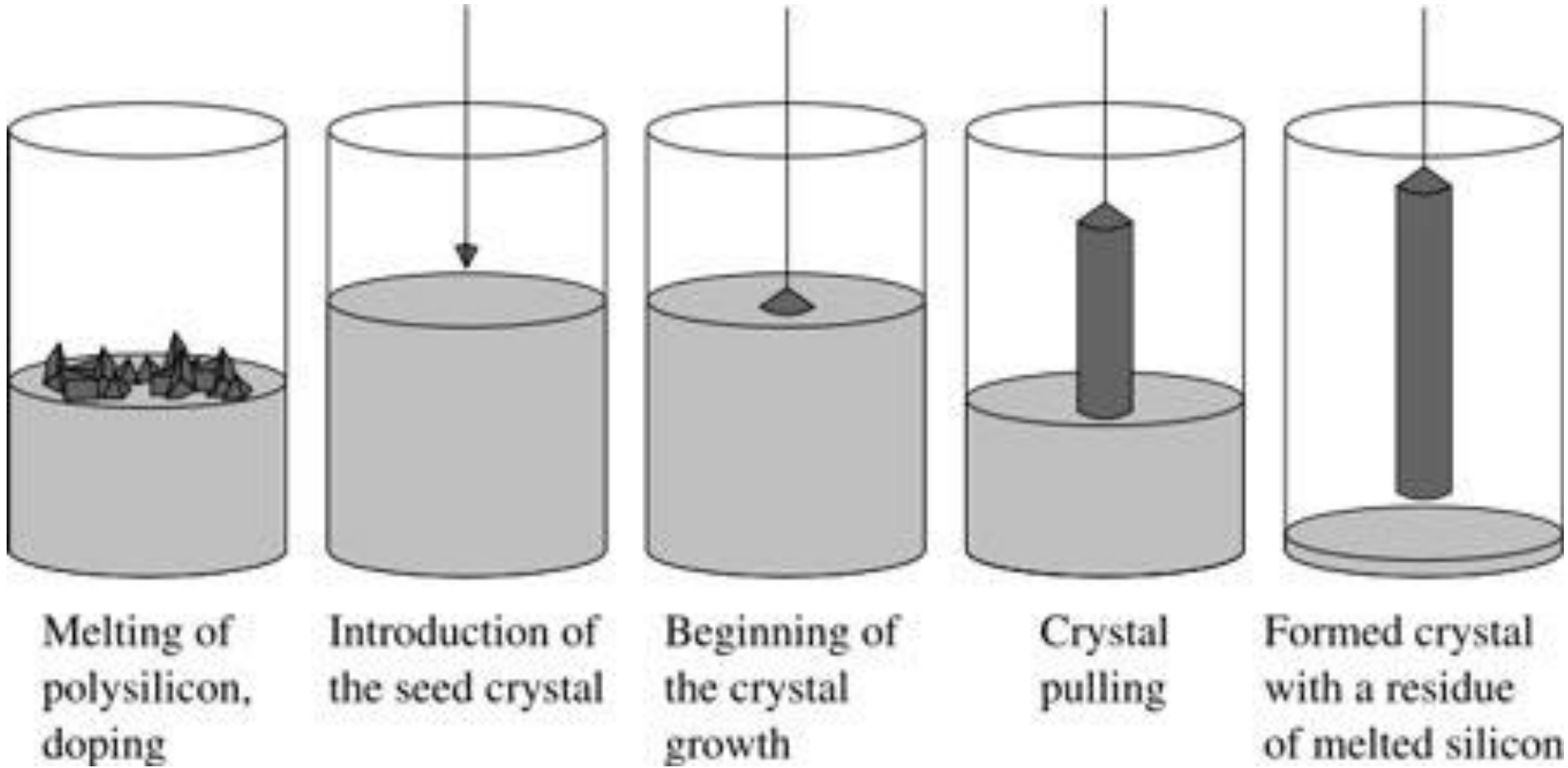

Crystal Growth from melt - Czochralski process

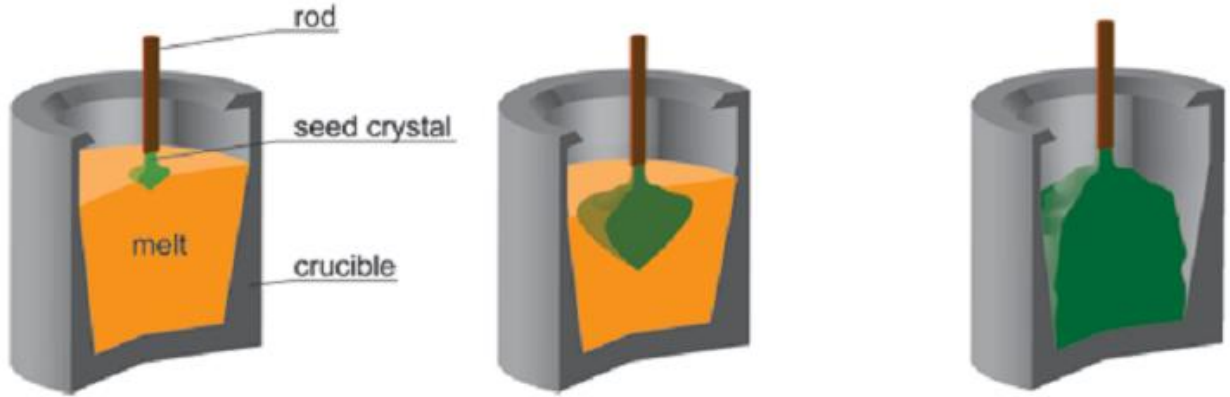
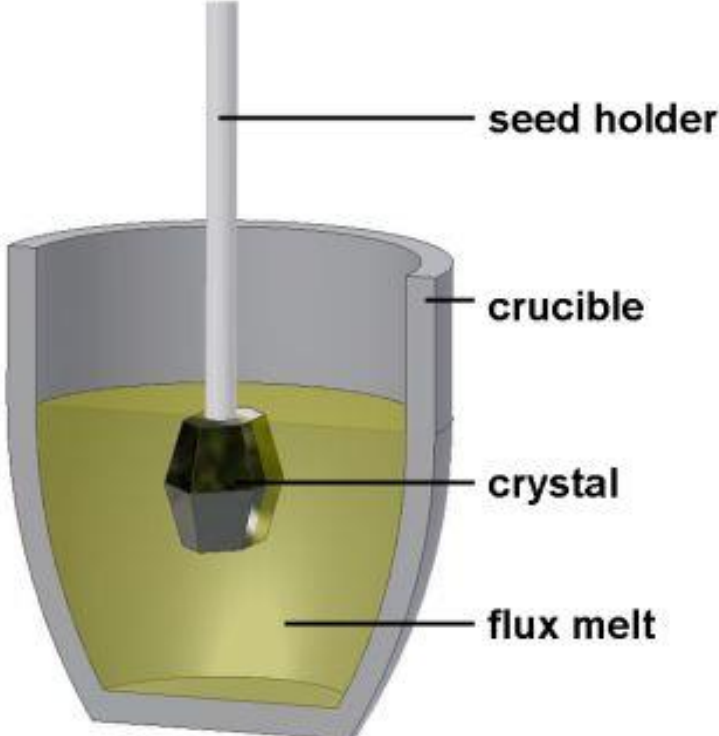

Czochralski process

- The SeG polycrystalline silicon is melted in crucible with trace levels of one of the dopants required in the completed device added

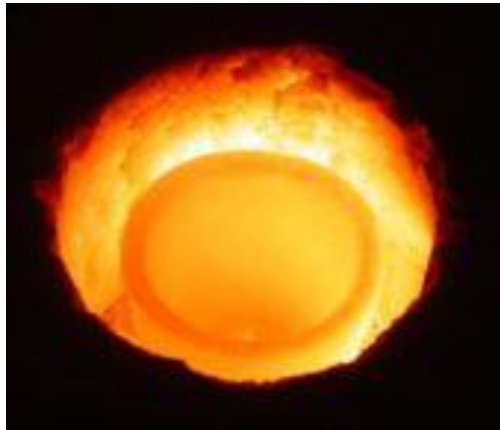

Czochralski process

- For solar cells ,boron , a p-type dopant ,is normally used, using a seed crystal and with very close temperature control, it is possible to pull from the melt.
- A large cylindrical single crystal of silicon, of diameter in excess of 12.5 cm and 1-2m in length are routinely grown in this manner.

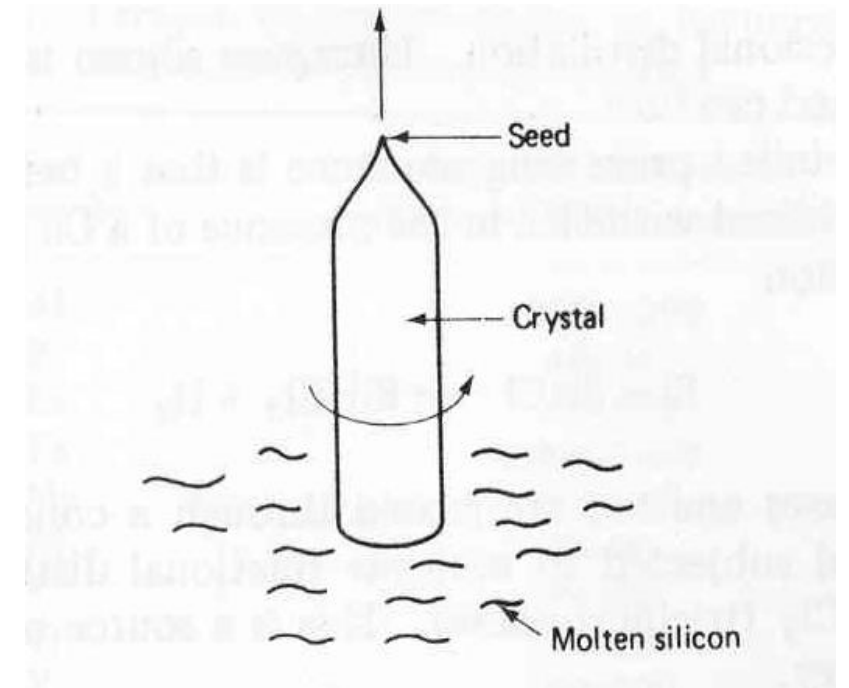
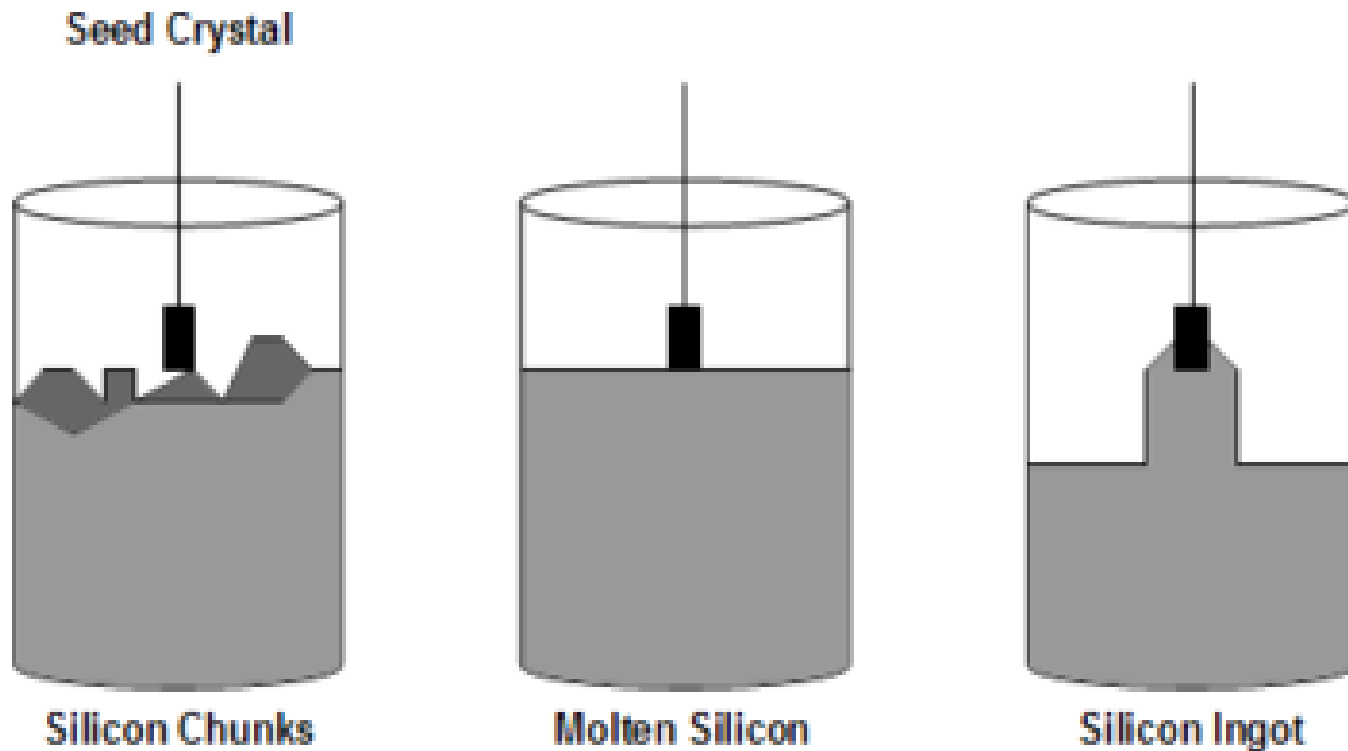

- Then the large single crystal is sliced up into wafers which are as thin as possible
(Silicon solar cells need only be 300 μm or so thick to absorb most of the appropriate wavelength in sunlight)

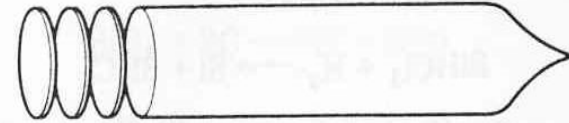

Figure 6.3. Slicing of thin wafers from a cylindrical ingot. The techniques used for this slicing process are described and compared in Ref. 6.3. About half the ingot is wasted as kerf or cutting loss in this process.



Czochralski Method ...

- This process uses Czochralski Crystal Grower.
- Poly-EGS is melted in a quartz-lined crucible at about 1412°C .
- Seed crystal is introduced into the molten poly-EGS to begin crystallization.
- Seed pulled slowly, allowing the crystal to grow on to it. Simultaneously, the crystal is rotated slowly to give slight stirring of the melt to prevent inhomogeneous solidification.
- Then Ingot is cooled at a very slower rate.

Contd...(Czochralski Method)

- This Technique is widely used in Growing Si, Ge and some compound semiconductor.
- In pulling compounds like GaAs from the melt, vaporization of volatile elements (e.g. As) is prevented.
- In one method, known as *Liquid Encapsulated Czochralski (LEC)* growth, the same can be done by using B_2O_3 (Boron Trioxide), which floats on the surface of the molten GaAs.

The Finished Crystal Parts...



Photograph taken from <http://www.seas.upenn.edu/>

Crystal Growth... <http://www.ecTech.in>



Single Crystal Ingots...



Photograph taken from <http://www.kasap3.usask.ca>

Crystal Growth... <http://www.ecTech.in>



BRIDGMAN AND STOCKBARGER METHODS

- Stockbarger method is based on a crystal growing from the melt, involves the relative displacement of melt and a temperature gradient furnace, **fixed gradient and a moving melt/crystal**
- Bridgman method is again based on crystal growth from a melt, but now a **temperature gradient furnace is gradually lowered** and crystallization begins at the cooler end, **fixed crystal and changing temperature gradient**
- **Both methods are founded on the *controlled solidification of a stoichiometric melt of the material to be crystallized in a temperature gradient***

Bridgman–Stockbarger technique

- Bridgman–Stockbarger technique is named after Harvard physicist Percy Williams Bridgman (1882-1961) and MIT physicist Donald C. Stockbarger (1895–1952).
- The technique includes two similar but distinct methods primarily used for growing boules (single crystal ingots), but which can be used for solidifying polycrystalline ingots as well.
- The methods involve heating polycrystalline material above its melting point and slowly cooling it from one end of its container, where a seed crystal is located.
- A single crystal of the same crystallographic orientation as the seed material is grown on the seed and is progressively formed along the length of the container.
- The process can be carried out in a horizontal or vertical orientation, and usually involves a rotating crucible/ampoule to stir the melt.
- The Bridgman method is a popular way of producing certain semiconductor crystals such as gallium arsenide, for which the Czochralski process is more difficult.

Bridgman–Stockbarger technique

- The difference between the Bridgman technique and Stockbarger technique is subtle:
- While both methods utilize a temperature gradient and a moving crucible, the Bridgman technique utilizes the relatively uncontrolled gradient produced at the exit of the furnace; the Stockbarger technique introduces a baffle, or shelf, separating two coupled furnaces with temperatures above and below the freezing point.
- Stockbarger's modification of the Bridgman technique allows for better control over the temperature gradient at the melt/crystal interface.
- When seed crystals are not employed as described above, polycrystalline ingots can be produced from a feedstock consisting of rods, chunks, or any irregularly shaped pieces once they are melted and allowed to re-solidify.
- The resultant microstructure of the ingots so obtained are characteristic of directionally solidified metals and alloys with their aligned grains.

Bridgman Method

The method involves heating polycrystalline material in a container above its melting point and slowly cooling it from one end where a seed crystal is located. Single crystal material is progressively formed along the length of the container. The process can be carried out in a horizontal or vertical geometry.

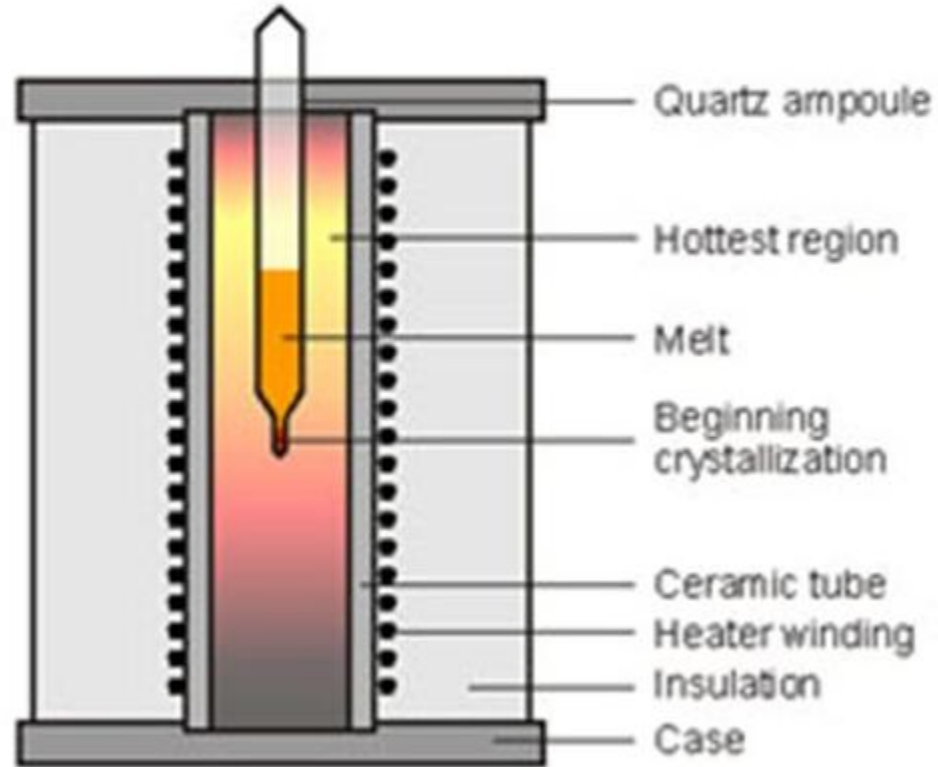

Gallium Arsenide Growth by Crystal Gradient Freeze

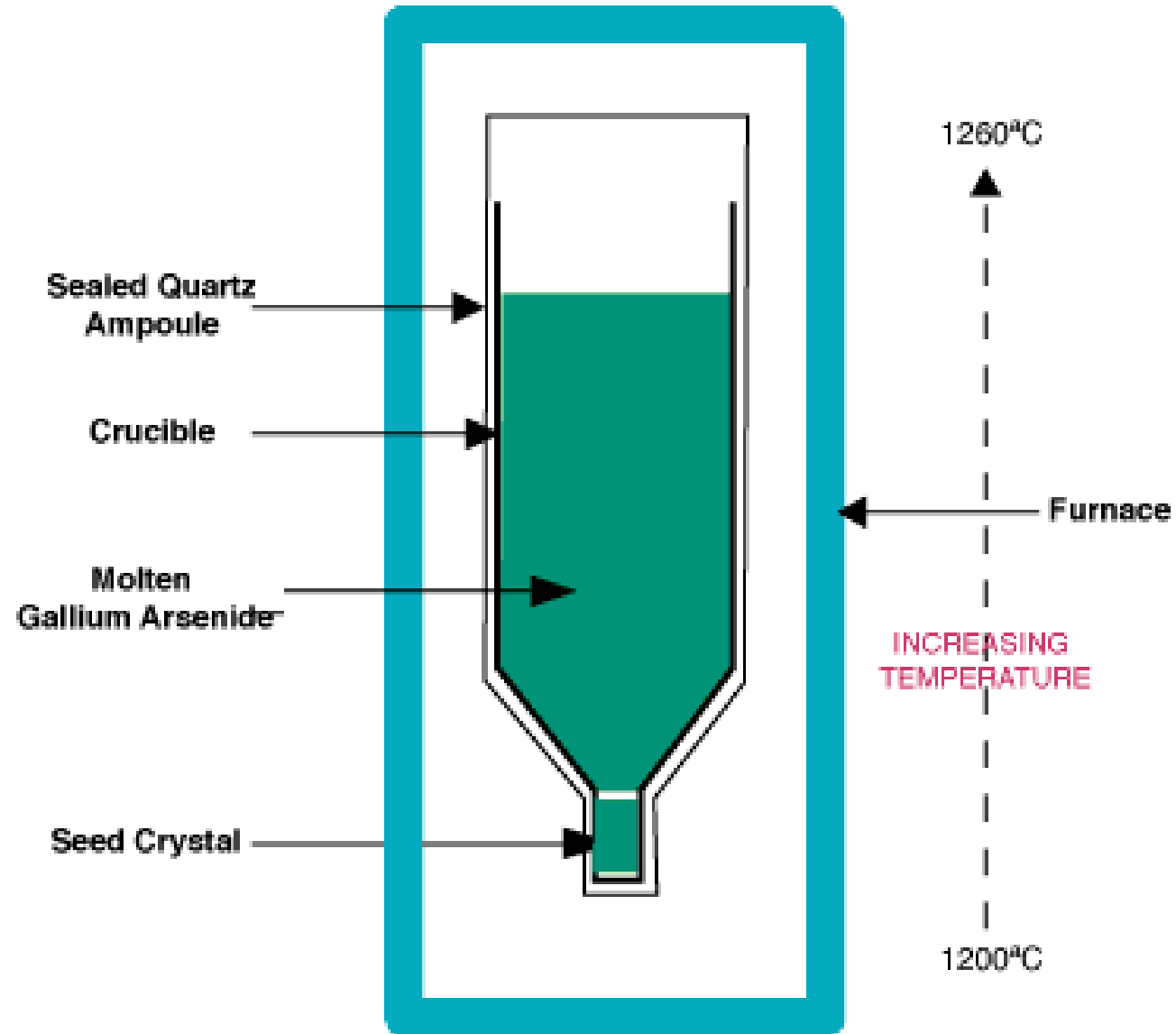

Zone melting

- Zone melting (or zone refining or floating zone process or travelling melting zone) is a group of similar methods of purifying crystals, in which a narrow region of a crystal is melted, and this molten zone is moved along the crystal.
- The molten region melts impure solid at its forward edge and leaves a wake of purer material solidified behind it as it moves through the ingot.
- The impurities concentrate in the melt, and are moved to one end of the ingot.
- Zone refining was used as a method to prepare high purity materials, mainly semiconductors, for manufacturing transistors.
- Its early use was on germanium for this purpose, but it can be extended to virtually any solute-solvent system having an appreciable concentration difference between solid and liquid phases at equilibrium.
- This process is also known as the float zone process, particularly in semiconductor materials processing.

Zone melting

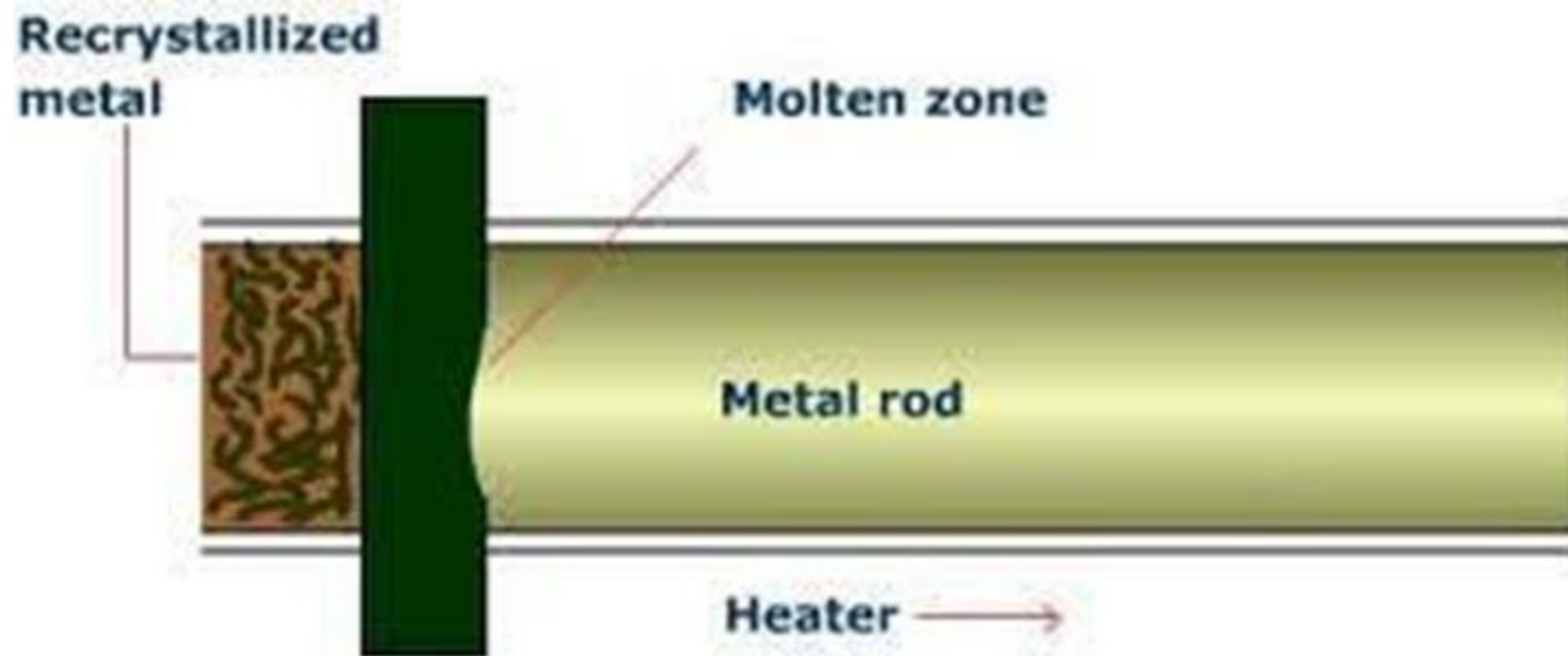

Methods of Crystallization – Low temperature solution growth

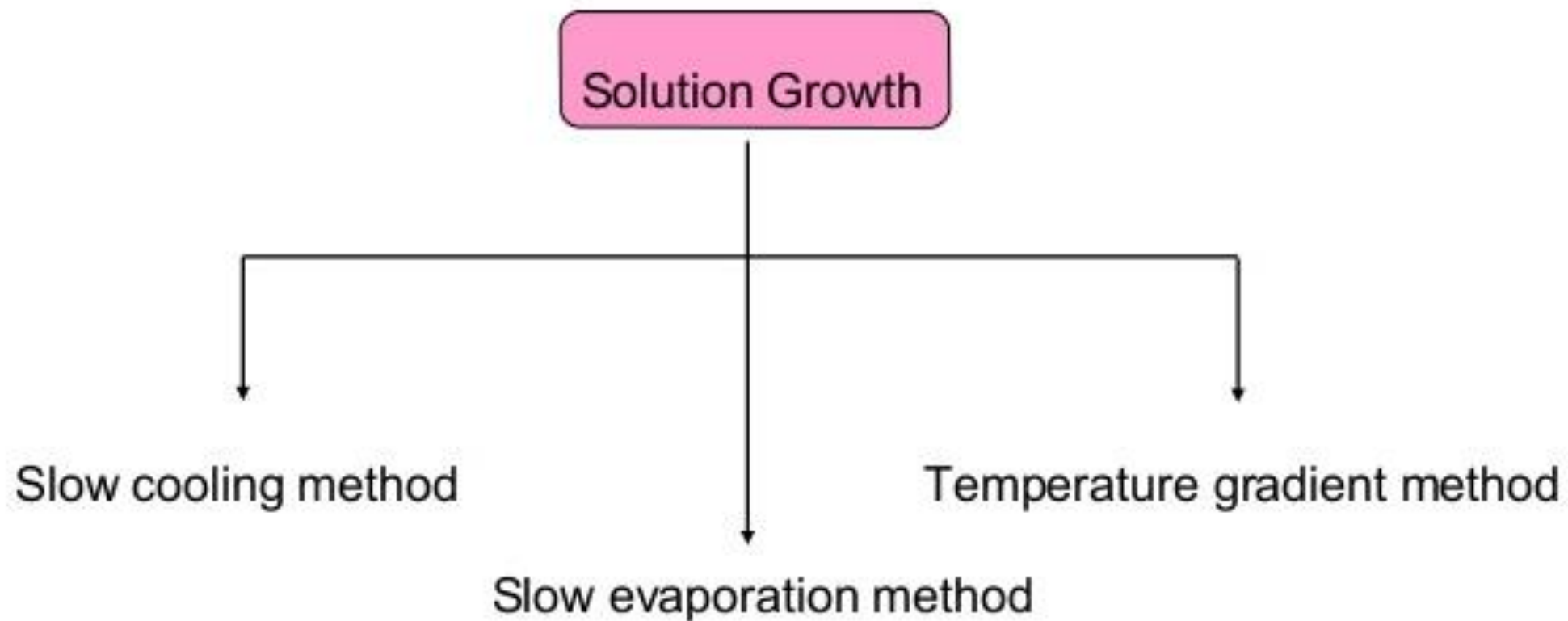

Crystallization from solution – Hydrothermal method

- Hydrothermal synthesis includes the various techniques of crystallizing substances from high-temperature aqueous solutions at high vapor pressures
- Hydrothermal synthesis can be defined as a method of synthesis of single crystals that depends on the solubility of minerals in hot water under high pressure.
- The crystal growth is performed in an apparatus consisting of a steel pressure vessel called an autoclave, in which a nutrient is supplied along with water.
- A temperature gradient is maintained between the opposite ends of the growth chamber.
- At the hotter end the nutrient solute dissolves, while at the cooler end it is deposited on a seed crystal, growing the desired crystal.
- Advantages of the hydrothermal method over other types of crystal growth include the ability to create crystalline phases which are not stable at the melting point. Also, materials which have a high vapour pressure near their melting points can be grown by the hydrothermal method.

Hydrothermal Crystal Growth Process

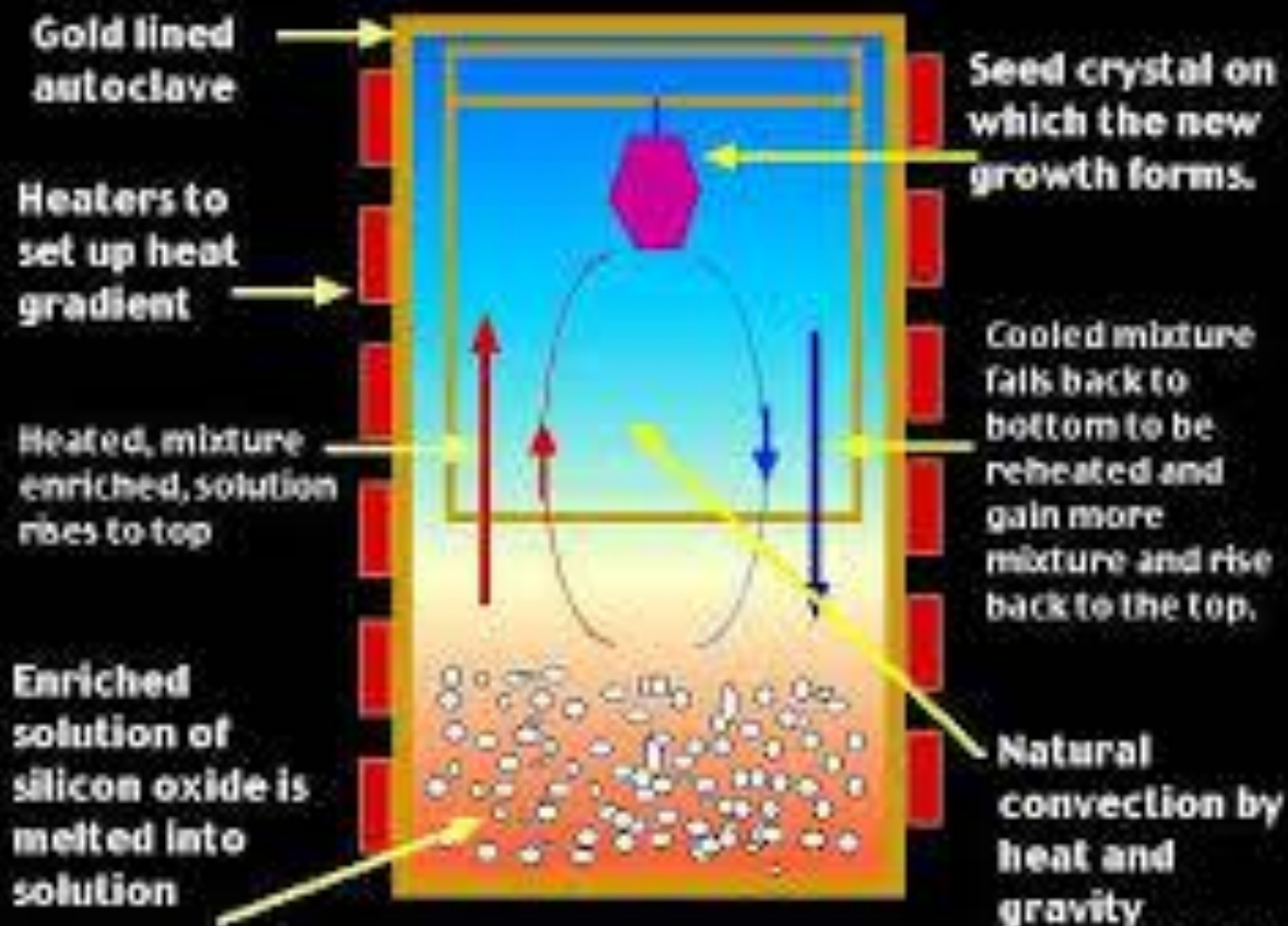

Solid Electrolytes

- Electrochemical cell and display, battery, fuel cell requires electrolytes
- Solid electrolytes are preferred than liquid phase electrolytes
- Solid electrolytes with mobile cations are silver tetraiodomercurate (Ag_2HgI_4) and sodium beta alumina
- Another recently developed fast cationic conductor includes NASICON (Sodium super ionic conductor of composition $\text{Na}_{1+x}\text{Zr}_2\text{P}_{3-x}\text{Si}_x\text{O}_{12}$)
- Anions typically have larger ionic radii than cations and energy barrier for diffusion through the solid is high
- Hence fast anion conduction is rare and limited to F^- and O^{2-}
- Anion conductors also play an important role in sensors and fuel cells
- Typical example is YSZ (Yttrium stabilized zirconia) of composition $\text{Y}_x\text{Zr}_{1-x}\text{O}_{2-x/2}$

Ionic vs. Electronic Conductivity

Metals

- Conductivity Range = $10 \text{ S/cm} < \sigma < 10^5 \text{ S/cm}$
- Electrons carry the current
- Conductivity Increases linearly as temperature decreases (phonon scattering decreases as $T \downarrow$)

Solid Electrolytes

- Conductivity Range = $10^{-3} \text{ S/cm} < \sigma < 10 \text{ S/cm}$
- Ions carry the current
- Conductivity decreases exponentially as temperature decreases (activated transport)

In order for an ion to move through a crystal it must hop from an occupied site to a vacant site. Thus ionic conductivity can only occur if defects are present. The two simplest types of point defects are Schottky and Frenkel defects.

Applications of Ionic Conductors

There are numerous practical applications, all based on electrochemical cells, where ionic conductivity is needed and it is advantageous/necessary to use solids for all components.

- **Batteries**
- **Fuel Cells**
- **Gas Sensors**

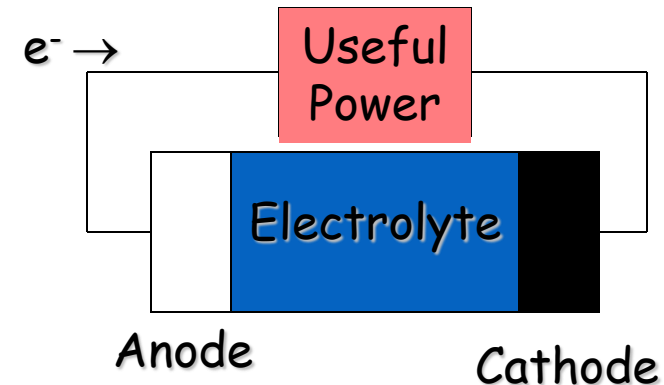

In such cells ionic conductors are needed for either the electrodes, the electrolyte or both.

- **Electrolyte** (Material needs to be an electrical insulator to prevent short circuit)
- **Electrode** (Mixed ionic and electronic conductivity is needed to avoid open circuit)

Solid Electrolytes

- Solid cationic electrolytes
- Solid anionic electrolytes
- Mixed ionic electronic conductors

Solid Electrolyte Materials

- **Ag⁺ Ion Conductors**

- AgI & RbAg₄I₅

- **Na⁺ Ion Conductors**

- Sodium β-Alumina (i.e. NaAl₁₁O₁₇, Na₂Al₁₆O₂₅)
- NASICON (Na₃Zr₂PSi₂O₁₂)

- **Li⁺ Ion Conductors**

- LiCoO₂, LiNiO₂
- LiMnO₂

- **O²⁻ Ion Conductors**

- Cubic stabilized ZrO₂ (Y_xZr_{1-x}O_{2-x/2}, Ca_xZr_{1-x}O_{2-x})
- δ-Bi₂O₃
- Defect Perovskites (Ba₂In₂O₅, La_{1-x}Ca_xMnO_{3-y}, ...)

- **F⁻ Ion Conductors**

- PbF₂ & AF₂ (A = Ba, Sr, Ca)

General Characteristics: Solid Electrolytes

1. A large number of the ions of one species should be mobile. This requires a large number of empty sites, either vacancies or accessible interstitial sites.
 - Empty sites are needed for ions to move through the lattice.
2. The empty and occupied sites should have similar potential energies with a low activation energy barrier for jumping between neighboring sites.
 - High activation energy decreases carrier mobility, very stable sites (deep potential energy wells) lead to carrier localization.
3. The structure should have solid framework, preferable 3D, permeated by open channels.
 - The migrating ion lattice should be “molten”, so that a solid framework of the other ions is needed in order to prevent the entire material from melting.
4. The framework ions (usually anions) should be highly polarizable.
 - Such ions can deform to stabilize transition state geometries of the migrating ion through covalent interactions.

Solid Cationic Electrolytes

- Solid inorganic electrolytes often have a low temp form in which the ions are ordered
- At high temp the ions become disordered over the sites and the ionic conductivity decreases
- Below 50°C, Ag_2HgI_4 has an ordered crystal structure where there is the close packed array of I^- ions and Ag^+ and Hg^{2+} ions are in the tetrahedral voids
- Not all the tetrahedral voids are occupied
- Below 50°C, electrical conductivity is low
- Above 50°C, Ag^+ and Hg^{2+} ions are randomly distributed over the tetrahedral sites and becomes a good electrical conductor
- At higher temp, close packed array of polarizable I^- ions easily deformed
- This results in low activation energy for the migration of Ag^+ ion from one ion site to the next

Solid Cationic Electrolytes

- Another Solid inorganic electrolytes is sodium β alumina
- Rigid and dense Al_2O_3 slabs are bridged by thin array of O^{2-} ions
- Plane containing bridging oxide ions also contains Na^+ ions
- Na^+ ions can move from site to site because there is no hindrance to this motion
- Similar rigid materials having planes or channels through which ions can move are known as framework electrolytes

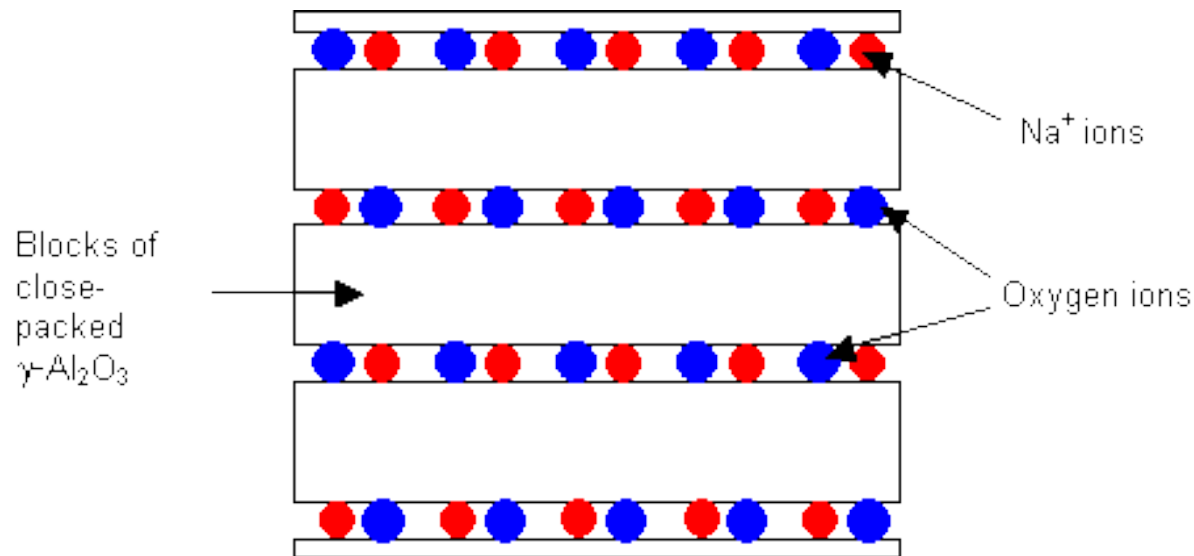

Solid Cationic Electrolytes

- NASICON is nonstoichiometric solid solution system with framework constructed from ZrO_6 octahedral and PO_4 tetrahedra
- A solid solution can be obtained by partially replacing P by Si to give $\text{Na}_{1+x}\text{Zr}_2\text{P}_{3-x}\text{O}_{12}$ with an increase in number of Na^+ ions for charge balance
- All the Na^+ sites are not filled and the vacant sites allow rapid migration of remaining Na^+ ions

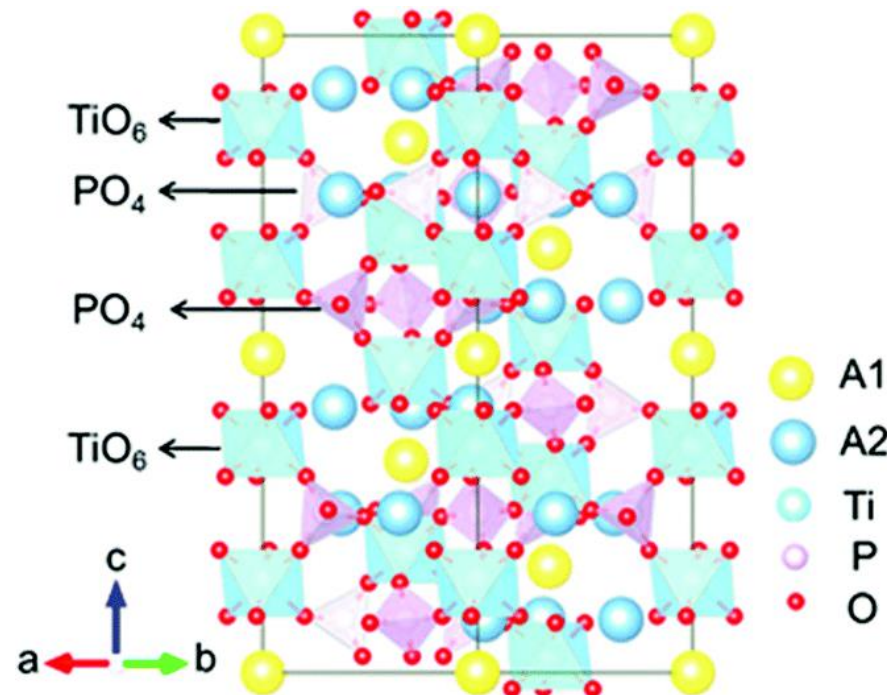

Solid Anionic Electrolytes

- PbF_2 when red hot is a good conductor of electricity
- Conductivity is due to the mobility of F^- ions through the solids
- This type of anion conductivity is shared by other crystal having fluorite structure
- Ion transport in these solids is believed to be by interstitialcy mechanism
- F^- ions first migrate from normal site to the interstitial site then moves to the vacant site

Mixed ionic – electronic conductors

- Solid material can exhibit both ionic and electron conductivity
- Ionic conductors such as sodium β'' alumina and YSZ have low electronic conductivity and they are widely used as sensors
- Combination of electronic and ionic conductivity is desirable and this kind of conduction is found in d-metal compounds
- Defects allow O^{2-} conduction and metal d-orbital provide an electronic conduction band
- Many such materials are perovskite based structures with mixed oxidation state at the B cation site
- Eg. Are $La_{1-x}Sr_xMnO_{3-y}$ and $La_{1-x}Sr_xFeO_{3-y}$
- Oxide systems are good electronic conductors with partially filled bands as a result of the non integral d-metal oxidation number and also can conduct by O_{2-} migration through the perovskite O_{2-} site
- This type of material is of use in solid oxide fuel cell (SOFC)

Solid solutions

Solid solution is basically a crystalline phase that can have variable composition

Two types of solid solutions

- 1) Substitutional solid solution
- 2) Interstitial solid solution

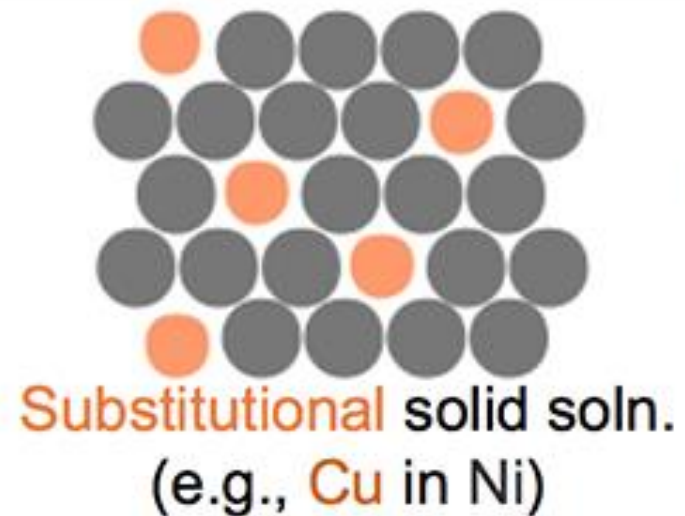

OR

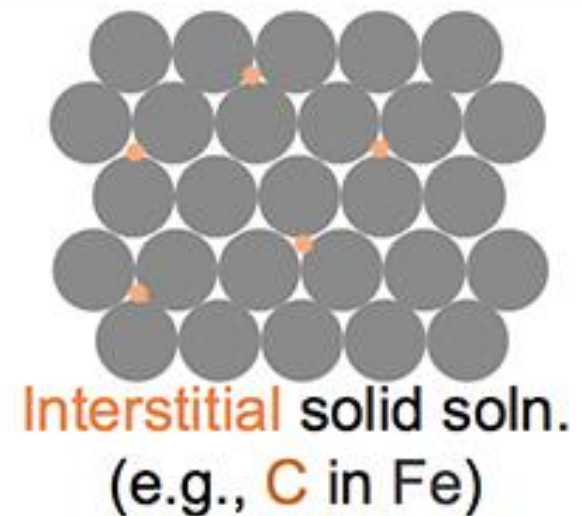

Substitutional Solid Solution

- Substitutional solid solution is a solid solution in which atoms of the solute metal occupy some of the sites of solvent metal atoms eg. Ag-Au alloys, Cu-Zn alloys
- Two metals can form substitutional solid solution if the following criteria are fulfilled
 - a) Atomic radii of the elements are within 15% of each other
 - More nearly alike they are, other things being equal, greater the degree of solid solubility
 - Radii of the pairs K^+/Rb^+ and Rb^+/Cs^+ are less than 15% and they can form solid solutions
 - Na^+ and K^+ are chemically similar and have similar structures, but K^+ is about 40% larger than Na^+ . So they do not form solid solution

**Substitutional
element replaces host atoms
in its lattice**

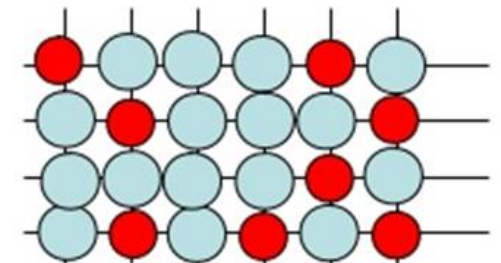

Substitutional Solid Solution

- Two metals can form substitutional solid solution if the following criteria are fulfilled
 - b) Crystal Structures of the two metals are the same
 - Continuous solid solutions are possible between Cu-Ni (both are ccp or fcc and ionic radii Cu 128 and Ni 125 pm), Au-Ag (both are ccp or fcc) or Mo-W (both are fcc)
 - But bcc Mo and fcc Ag cannot form solid solutions even though their radii differ by less than 6%
 - c) Electropositive character of the two components are similar otherwise compound formation takes place where electrons are transferred between atoms
 - d) Condition for relative valency
 - Continuous solid solution can occur only between atoms having same valency in the alloy
 - Elements of high valency dissolve to a larger extent in a lower valency solvent than the reverse
This is so called nonreciprocity rule of solid solutions

Substitutional Solid Solution

- Vegard's Law states that change in unit cell dimensions should be linear with change in composition
- Because both metals have identical structures. Solid solutions decrease the size of the larger metal's unit cell or increase that of the smaller metal

Substitutional solid solution

- Substitutional solid solutions can be of two types
 - 1. Ordered solid solution
 - 2. Disordered solid solution

Ordered solid solution

- If the atoms of the solute occupy certain preferred sites in the lattice of the solvent, an ordered solid solution is formed. It may occur only at certain fixed ratios of the solute and solvent atoms.
- In Cu – Au system, Cu atoms occupying the face-centered sites and Au atoms occupying the corner sites of the FCC unit cell.

Ordered Substitutional solid solution

**Substitutional
element replaces host atoms
in an orderly arrangement**

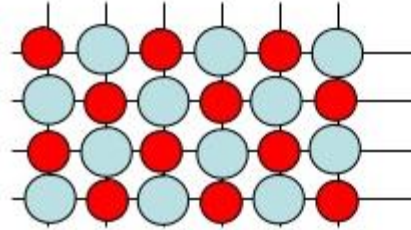

e.g., Ni-Al, Al-(Li,Zr)

Disordered solid solution

- If the atoms of the solute are present randomly in the lattice of the solvent, it is known as disordered solid solution.
- Most of the solid solutions are disordered solid solutions

Solid solutions in ceramic and metallic compounds

Solid solutions occur also in ionic phases, e.g.

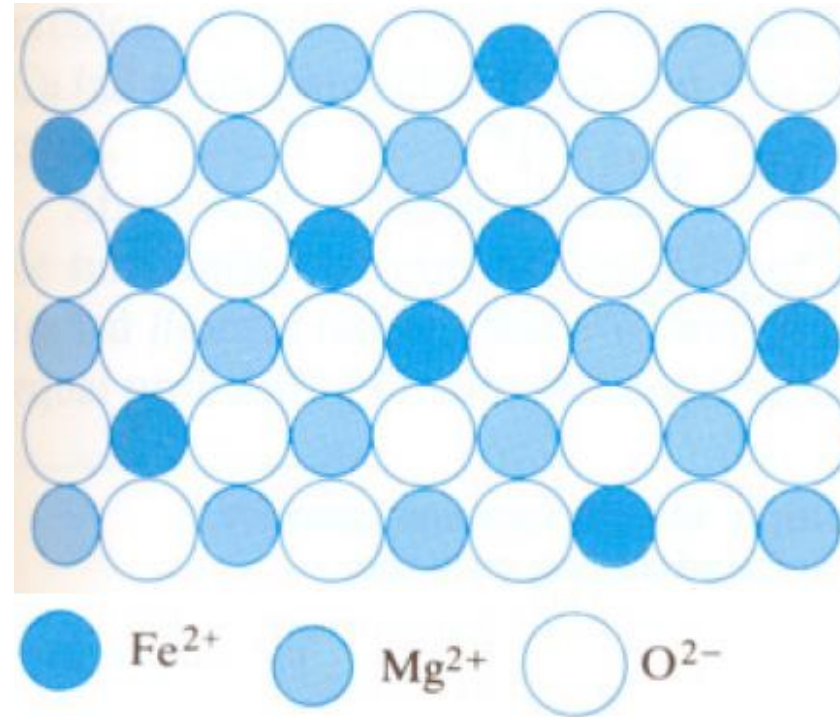

**Substitutional Solid Solution
in a Compound. Fe^{2+} is
substituted for Mg^{2+} in the
 MgO structure.**

Interstitial Solid Solution

- Interstitial solid solution are formed between metals mainly d-metals such as Fe, Co, Ni etc and small atoms such as B, C and N that can inhabit in the interstices in the structure
- A simple whole number ratio of metal and interstitial atoms as in tungsten carbide
- Small atoms are randomly distributed in the available space
- Former substances are called true compounds and latter are considered as interstitial solid solutions or non-stoichiometric compounds
- Requirement for interstitial solid solution formation is that size of the solute atom must be suitable to just fit in the octahedral hole in the close packed structure of the host crystal
- An important example is carbon steel in which carbon atoms occupy sme of the octahedral hole of Fe bcc lattice

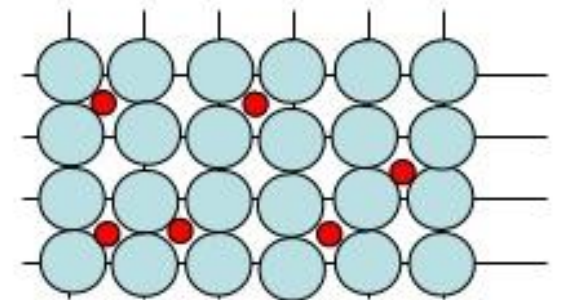

Interstitial Solid Solution

- For interstitial solid solutions, the Hume-Rothery rules are:
- Solute atoms should have radius no larger than 59% of the radius of solvent atoms.
 - The solute and solvent should have similar electronegativity.
 - They should show a wide range of composition.
 - Valency factor: two elements should have the same valence.
 - The greater the difference in valence between solute and solvent atoms, the lower the solubility.

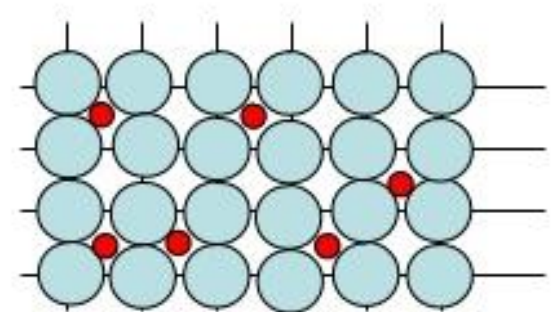

Metals and Alloys

- Alloys are substitutional solid solutions of one metal in another
- In d block metals, maximum atomization energies seem to correspond to half filling of one valence 's' and 5 d orbitals
- This is a consequence of Engel-Brewer rule which states that the bonding energy of a metal or alloy depends on the average number of unpaired electrons per atom available for bond formation
- This suggest that bonding in metals is pure covalent bonding though metals have quite different properties than non-metals

Intermetallic compounds

- An intermetallic compound is a type of metallic alloy that forms a solid-state compound exhibiting defined stoichiometry and ordered crystal structure.
- These compounds have more nearly covalent than metallic bonding
- They are usually semiconductors than metallic conductors
- Intermetallic compounds do not exist after the crystal has been melted
- Their stability is related to the bonding forces within the crystal lattice
- Band structure of the metal give the stability for any particular intermetallic phase
- Particular arrangement of metal valence electrons within an energy band due to appropriate arrangement of atomic nuclei in the lattice
- This is the basis of Hume-Rothery rule, which states that for any particular phase, ratio of total number of atoms to the total number of electrons is constant

Intermetallic compounds.

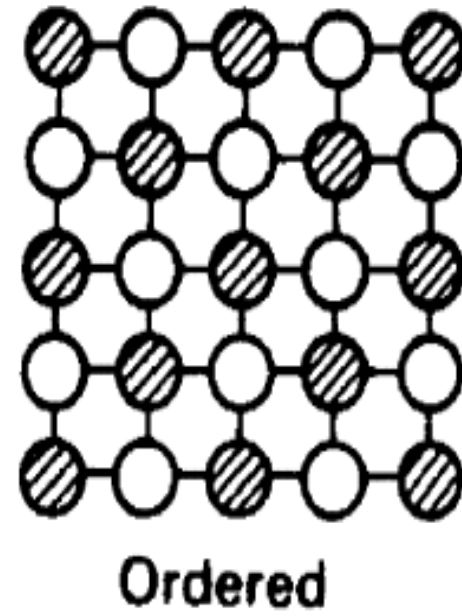
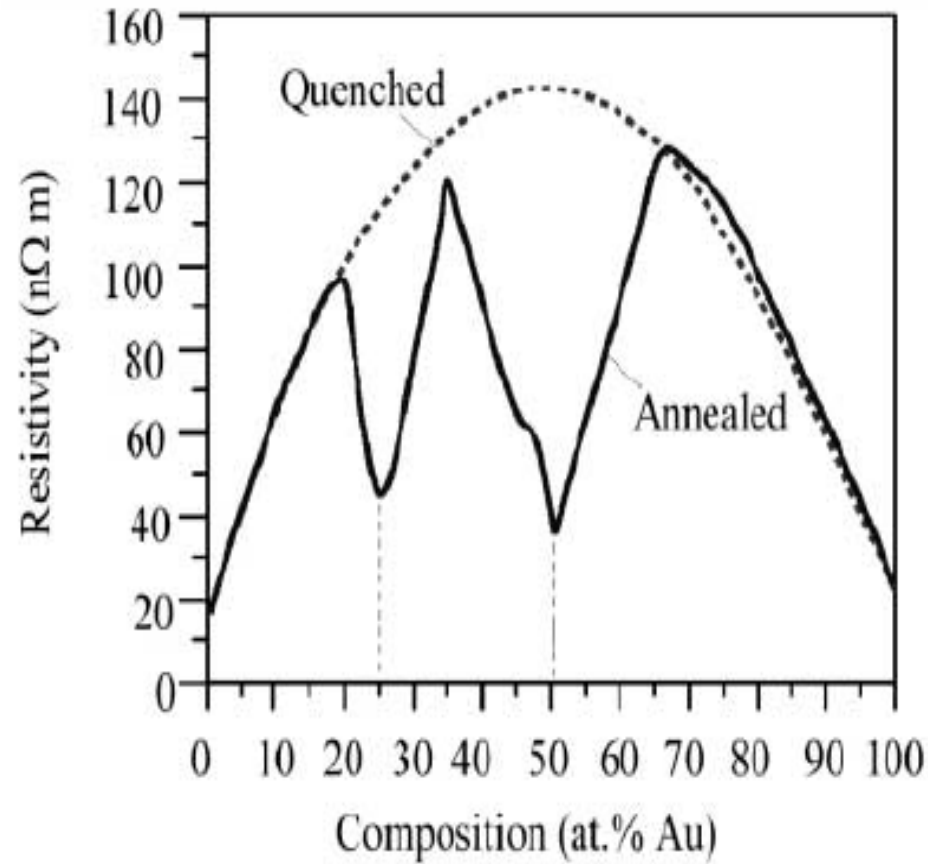

Ordered FCC structure.

Cu-Au resistivity vs. Au content.

Ordered intermetallic compounds are formed if the components have very different electronegativity.

Zintl Phase

- If intermetallic compound formed between a very electropositive metal and a less electropositive metal (eg. Na and Zn), compound formed is not an alloy but has some ionic character
- Such compounds are called Zintl phases
- These are not fully ionic and have some metallic properties
- They are brittle